

TUUCI



BORN IN MIAMI

EFFECTIVE NOVEMBER 1, 2023

TUUCI® SHADE INDEX

PREMIUM PARASOLS

OCEAN MASTER MEGA MAX CENTER POST



CLASSIC
24

OCEAN MASTER MAX CENTER POST



CLASSIC
30



MANTA
31



ZERO HORIZON
31



CRESCENT
32



F-1
32



NORTHSTAR
NAUTICAL TEAK
34



NAUTICAL TEAK
36

OCEAN MASTER MAX CANTILEVER



CLASSIC
46



MANTA
47



ZERO HORIZON
47



CLASSIC DUAL
48



STINGRAY
48

SCULPTURE

OCEAN MASTER M1 CENTER POST



CLASSIC
56



MANTA
57



ZERO HORIZON
57



RAZOR
58



CRESCENT
58



POLYNESIAN
58



PAGODA
59



CUPOLA
59

OCEAN MASTER M1 CANTILEVER



CLASSIC
68



SHADE POD
DUO
68



SHADE POD
TRIO
69



SHADE POD
QUAD
69

ESSENTIAL PARASOLS

BAY MASTER MAX CENTER POST



CLASSIC
78

BAY MASTER M1 CENTER POST



CLASSIC
84



FIBER-FLEX
85



MARITIME HARDWOOD
87

BAY MASTER M1 CANTILEVER



CLASSIC
94



SWIM UNDER
94

CABANAS



SOLANOX
100



ATLANTIS
106



GRAND PACIFIC
106



ST. TROPEZ
106

LOUNGES



SOLANOX
DOUBLE CHAISE
112



MERCURY
112



CRESCENT
112

HAMMOCK



AIR LOUNGE
113

PLANTERS & SCREENS

URBAN GARDEN



HIGHLAND
(OPTIONAL SCREEN)
118



MAINLAND
(OPTIONAL SCREEN)
122



FREESTANDING
TRELLIS SCREEN
126



LIGHT POST
(LIGHTS NOT INCLUDED)
126

STEPS TO COMPLETE A TUUCI® ORDER

1

3



4

6

7

8

9

OCEAN MASTER MAX CLASSIC				STANDARD INCLUDED					FINISH UPGRADE		LIFT UPGRADE	MAST UPGRADE	CANOPY ENHANCEMENT				COVER BAG	ANCHOR	
				FABRIC	VENT	PROFILE	LIFT	FINISH	655	1610	1330	680	280	680	680	910	720	WEIGHT	
		MAST DIAMETER	LIST PRICE EUR	ALL MXT SERIES. SEE PAGE 133 FOR DETAILS & OTHER OPTIONS.					POWDER COAT OPTIONS SEE PAGE 22 FOR DETAILS		EASYDRIVE CRANK LIFT W/ TELESCOPING MAST	NORTHSTAR MAST - SEE PAGE 142 FOR DETAILS (NOT AVAILABLE WITH LIGHT OR HEATERS)	CONTRASTING BINDING (CANOPY AND VENT)				CUSTOM PROTECTIVE COVER	MINIMUM RECOMMENDED WEIGHT	
				SINGLE WIND VENT (MATCHING STANDARD, CONTRASTING OPTION)	MARKET CUT PROFILE	AUTO-LOC MARINE PULLEY LIFT	EASYDRIVE CRANK LIFT W/ TELESCOPING MAST	POLISHED TITANIUM	PLANTATION ALUMA-TEAK™ OPTIONS SEE PAGE 23 FOR DETAILS				15CM ACCENT BORDER ON CANOPY						
SQUARE			LEVEL C								PP. 142-143 FOR MORE ENHANCEMENTS								
OMX8SQ	8.0' / 2.45m	60mm	4110	INCL	INCL	INCL	INCL	—	INCL	o	o	o	o	o	o	o	o	CX2	90KG
OMX10SQ	10.0' / 3.0m	60mm	5150	INCL	INCL	INCL	INCL	—	INCL	o	o	o	o	o	o	o	o	CX2	90KG
OMX12SQ	12.0' / 3.65m	73mm	7540	INCL	INCL	INCL	—	INCL	INCL	o	o	—	o	o	o	o	o	CX4	127KG
OMX14SQ	14.0' / 4.25m	73mm	8790	INCL	INCL	INCL	—	INCL	INCL	o	o	o	o	o	o	o	o	CX5	180KG
OMX16SQ	16.0' / 4.9m	73mm	10140	INCL	INCL	INCL	—	INCL	INCL	o	o	o	o	o	o	o	o	CX5	180KG

2

Go to anchor pages to select the appropriate anchor and weight

5

Select an option from each of the following five categories:

- Product collection
- Shape & size (all standard options are included)
- Fabric
- Finish
- Anchor selection (refer to anchor pages)

Select from the following categories for optional upgrades:

- Lift upgrade
- Mast upgrade (only available on a couple of products)
- Canopy enhancement options (customize the look of the canopy)
- Protective cover bags

For more information or to place an order, contact your Tuuci representative or locate a dealer at tuuci.com/where-to-buy. Prices subject to change.

QUICK SHIP HIGH PERFORMANCE TEXTILES

Level C | Only available on xpress program | 2-5 week lead time

Tuuci brings you a curated collection of high performing solution-dyed acrylic fabrics from the top rated resources around the world. This selection reflects a range of dynamic colors to fit your outdoor shade needs.



Natural
MXT 9003



Scallop
MXT 9004



Malt
MXT 9102



Platinum
MXT 9007



Sugar
MXT 9097



Pumice
MXT 9091

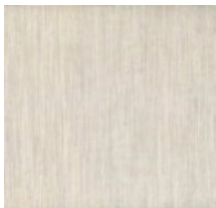

Fossil
MXT 9083

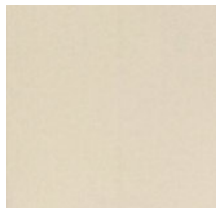

Crème
MXT 9100



Sand
MXT 9093



Stone
MXT 9096



Dolphin
MXT 9008

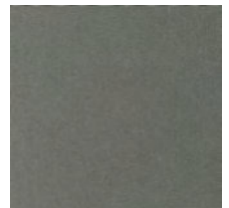

Anchor Gray
MXT 9009



Stingray
MXT 9050

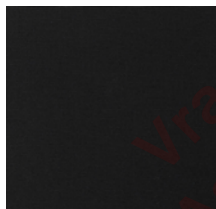

Black
MXT 9006

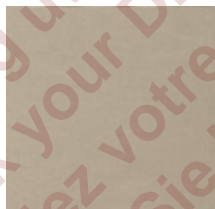

Ecru
MXT 9005

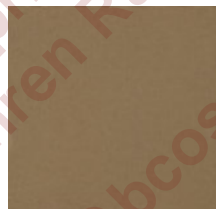

Sahara
MXT 9051



Truffle
MXT 9010

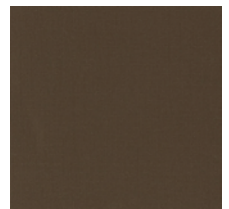

Cocoa Bean
MXT 9045



Sunburst
MXT 9016



Grapefruit
MXT 9307



Nectarine
MXT 9304

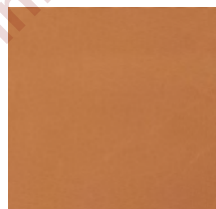

Apricot
MXT 9053

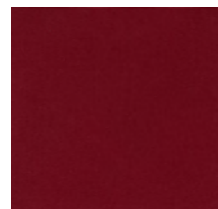

Scarlet
MXT 9014

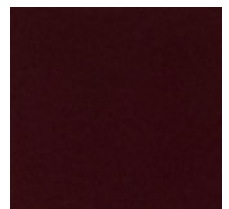

Cabernet
MXT 9042



Lichen
MXT 9113

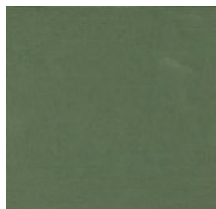

Sage
MXT 9041

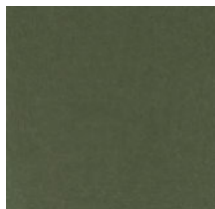

Moss
MXT 9296



Heaven
MXT 9112



Cerulean
MXT 9109

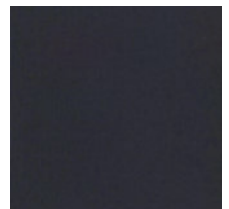

Admiral Navy
MXT 9044

XPRESS PRODUCT

OCEAN MASTER M1 CLASSIC

The Ocean Master M1 market style parasol is the culmination of durable engineering, stylish profiles and functional shade design. Manufactured to marine specifications, all Ocean Master M1 parasols feature 100% replaceable parts for easy service and a 15/5-year warranty.

FINISH OPTIONS

STANDARD



Polished Titanium

PLANTATION ALUMA-TEAK

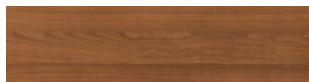

Natural +€445



Weathered +€445

POWDER COAT



Oyster +€190



Black Sea +€190



Auto-LOC marine pulley lift

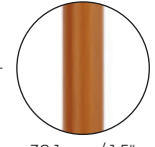

38.1mm / 1.5" mast diameter

Finish shown: Natural Aluma-TEAK

SHAPES & SIZES

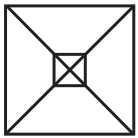

225CM / 7.5' SQUARE

Level C — #9003 Natural

Level C — all colors

Min. weight of anchor:

€1380

€1610

41KG



260CM / 8.5' HEXAGON *

Level C — #9003 Natural

Level C — all colors

Min. weight of anchor:

€1560

€1795

48KG

FABRICS

XPRESS - STANDARD

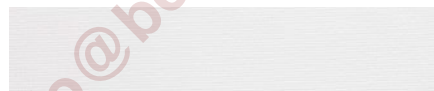

Natural — MXT 9003. 2 week lead time

XPRESS - OTHERS

All Quick Ship Level C fabrics have a 2-5 week lead time. See pg. 12.

FEATURES & UPGRADES

LIFT SYSTEM



Auto-LOC Marine Pulley Lift

* TILT SYSTEM



Stainless Steel Twist Collar Tilt

PROTECTIVE COVER



Standard Polyester Dark Grey + €155

XPRESS PRODUCT

OCEAN MASTER M1 CLASSIC (AUTOSCOPE)

The Ocean Master M1 market style parasol is the culmination of durable engineering, stylish profiles and functional shade design. Manufactured to marine specifications, all Ocean Master M1 parasols feature 100% replaceable parts for easy service and a 15/5-year warranty. *Please note that this product requires a 51mm / 2.0" security sleeve.*

FINISH OPTIONS

STANDARD



Polished Titanium

PLANTATION ALUMA-TEAK



Natural +€445

POWDER COAT



Oyster +€190



Weathered +€445



Black Sea +€190

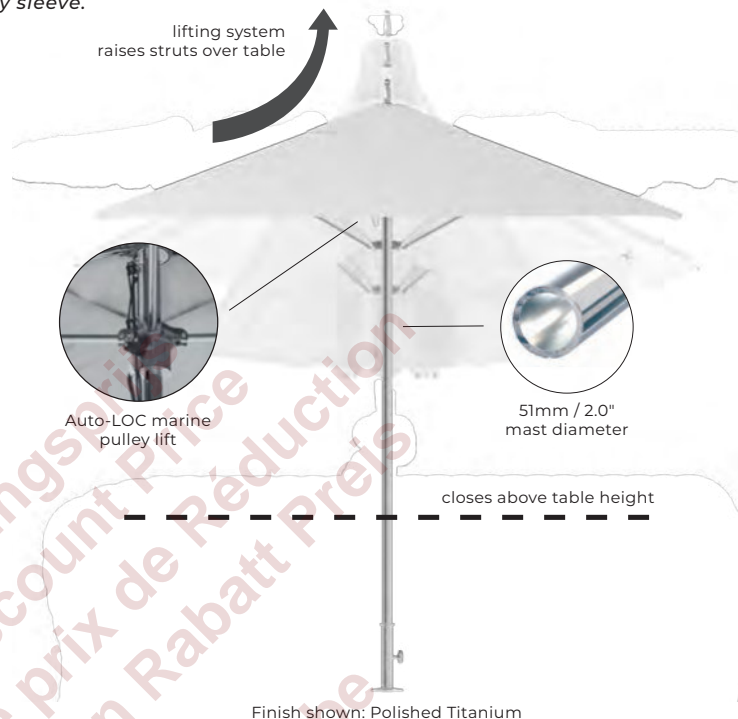

SHAPES & SIZES

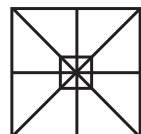

305CM / 10.0' SQUARE

Level C — #9003 Natural

Level C — all colors

Min. weight of anchor:

€2570

€2835

64KG

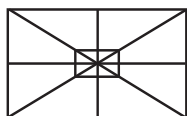

245x365CM / 8x12.0' RECTANGLE

Level C — #9003 Natural

Level C — all colors

Min. weight of anchor:

€2570

€2835

64KG

FABRICS

XPRESS - STANDARD



Natural — MXT 9003. 2 week lead time.

XPRESS - OTHERS

All Quick Ship Level C fabrics have a 2-5 week lead time. See pg. 12.

FEATURES & UPGRADES

LIFT SYSTEM



Auto-LOC Marine Pulley Lift

PROTECTIVE COVER



Standard Polyester Dark Grey + €155

XPRESS PRODUCT

OCEAN MASTER MAX CLASSIC CANTILEVER

The Ocean Master MAX Classic Cantilever is simply art and engineering harmonizing in a symphony of shade. The polished and anodized marine grade canopy structure cantilevers from a sturdy, oval shaped mast inspired by sailing yachts. With the combined features of an ultra strong aluminum milled fulcrum and telescoping mast, the canopy of this side post parasol easily closes over tables and chairs. All MAX Classic Cantilever parasols feature 100% replaceable parts for easy service and a 15/5-year warranty.

FINISH OPTIONS

STANDARD



Polished Titanium

PLANTATION ALUMA-TEAK



Natural +€1610



Weathered +€1610

POWDER COAT



Oyster +€655



Black Sea +€655



Finish shown: Oyster

SHAPES & SIZES

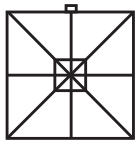

SQUARE (INCL. HWS)	305CM/10.0'	400CM/13.0'
Level C — #9003 Natural	€8920	€10660
Level C — all colors	€9440	€11155
Min. weight of anchor:	180KG	180KG

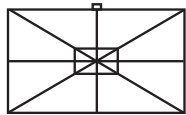

RECTANGLE (INCL. HWS)	305x425CM / 10x14.0'
Level C — #9003 Natural	€10295
Level C — all colors	€10815
Min. weight of anchor:	180KG

FABRICS

XPRESS - STANDARD

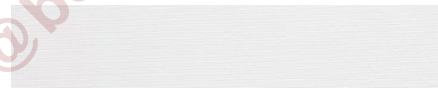

Natural — MXT 9003. 2 week lead time.

XPRESS - OTHERS

All Quick Ship Level C fabrics have a 2-5 week lead time. See pg. 12.

FEATURES & UPGRADES

LIFT SYSTEM



EasyDrive Crank w/ telescoping mast

ENHANCEMENT



High Wind Stabilizers included

PROTECTIVE COVER



Standard Polyester Dark Grey + €330

XPRESS PRODUCT

OCEAN MASTER MAX CLASSIC CANTILEVER — LIGHT, HEATING & AUTOMATION

Tuuci's Automated Classic Cantilever shade platform redefine shade technology. Automation and shade integrate seamlessly with our convenient and intuitive push-button interface. Shading, lighting, and heating come alive at your fingertips with a one-touch control panel featuring smart safety protocols. A whole new level of intelligent design has been reached. See page 49 for more information on our light, heating and automation options.

FINISH OPTIONS

STANDARD



Polished Titanium

PLANTATION ALUMA-TEAK



Natural +€1610



Weathered +€1610

POWDER COAT



Oyster +€655



Black Sea +€655



Finish shown: Black Sea

SHAPES & SIZES

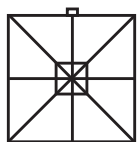

400CM / 13.0' SQUARE (INCL. HWS)

Level C — all colors

€17680

Min. weight of anchor:

180KG

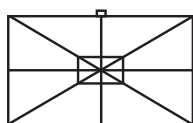

305x425CM / 10x14.0' RECTANGLE (INCL. HWS)

Level C — all colors

€17340

Min. weight of anchor:

180KG

FABRICS

XPRESS - OTHERS

All Quick Ship Level C fabrics have a 2-5 week lead time. See pg. 12.

FEATURES & UPGRADES

LIFT SYSTEM



Motorized open/close system

ENHANCEMENT



High Wind Stabilizers included

PROTECTIVE COVER



Anchor Gray MXT 9009 + €935
Other colors + €1170
Only available in MXT 9000-9600

XPRESS PRODUCT

AIR LOUNGE + WAVE STAND

From sunrise to sunset Tuuci's Air Lounge hammock is the ultimate way to relax. Designed for tranquility, its unique beauty is matched only by its durable construction of expandable ultra comfort sun mesh fabric with UV stabilized sun dye and durable hardwood stretcher bars. Years of awe-inspiring relaxation await your arrival.



SHAPES & SIZES







DIMENSIONS (IN CM)						
SIZE	A	B	C	D	E	F
435x140cm	432	140	119	183	132	6

PRICES

WAVE STAND + TWIN AIR LOUNGE XL (WHITE OR BLACK)	€ 3220
TWIN AIR LOUNGE	€ 720
AIR LOUNGE STRAPS	€ 90



ANCHORS - M1 CENTER POST

ABOVE GROUND

			LIST PRICE EUR	BASE DIAMETER	ANCHOR COVER*	
					POWDER COAT: OYSTER OR BLACK SEA	ALUMA-TEAK™: NATURAL OR WEATHERED
 High wind areas may require additional weight and security system aluma-crete anchors are concrete filled with stainless steel security sleeve. G-plate anchors are of galvanized steel with stainless steel security sleeve. * anchor covers are for the top g-plate only.	ALUMA-CRETE ROUND INCL. WHEELS AVAILABLE IN: silver glacier white oyster black sea natural +€140 weathered +€140	43 KG (95 LBS)	505	61CM	N/A	N/A
		68 KG (150 LBS)	570	71CM	N/A	N/A
	G-PLATE ROUND	48 KG (105 LBS)	765	76CM	240	285
	G-PLATE ROUND DOUBLE STACK COMBO	66 KG (145 LBS)	960	76+45CM	N/A	N/A
		82 KG (180 LBS)	1130	76+61CM	N/A	N/A
		96 KG (210 LBS)	1300	76+76CM	240	285
	G-PLATE SQUARE	41 KG (90 LBS)	685	61CM SQ	240	285
		64 KG (135 LBS)	955	76CM SQ	365	445
	G-PLATE SQUARE DOUBLE STACK COMBO	90 KG (200 LBS)	1255	91CM SQ	365	445
		82 KG (180 LBS)	1145	61CM SQ	240	285



* 2.0" / 51mm security sleeve required for all parasols with autoscope. Upcharge is €70,-

IN GROUND & ACCESSORIES

	STAINLESS STEEL FLUSH MOUNT	FOR CONCRETE INSTALLATIONS INCLUDES 3 CONCRETE DROP-IN ANCHOR BOLTS INCLUDES 61CM / 24" ALUMINUM EXTENSION SLEEVE FOR USE WITH A 38.1MM / 1.5" MAST	530
	TUFF WHEELS FOR G-PLATE ANCHORS	FOR USE WITH GALVANIZED STEEL SQUARE ANCHORS * NOT POSSIBLE IN COMBINATION WITH G-PLATE SQUARE 41 KG / 82 KG	405
	STAINLESS STEEL WHEEL TRAY	INDEPENDENT ASSEMBLY FOR USE WITH GALVANIZED STEEL ROUND ANCHORS (TRANSPORT, TILT & ROLL)	315

ANCHORS - MAX CENTER POST & CANTILEVER

ABOVE GROUND





 <p>High wind areas may require additional weight and security system</p> <p>G-MAX plate anchors are of galvanized steel with stainless steel security sleeve. Stainless steel security sleeve & beauty cover ship with all MAX parasols. * anchor covers are for the top G-MAX plate only.</p>					ANCHOR COVER*			
			LIST PRICE EUR	BASE DIMENSIONS	POWDER COAT: OYSTER OR BLACK SEA	ALUMA-TEAK™: NATURAL OR WEATHERED	TUFF WHEELS	
		G-MAX PLATE SQUARE	91 KG (200 LBS)	1025	91CM	365	445	405
		G-MAX PLATE SQUARE DOUBLE STACK COMBO	127 KG (280 LBS)	1455	76+76CM	365	445	405
			181 KG (400 LBS)	2050	91+91CM	365	445	405
G-MAX PLATE SQUARE TRIPLE-STACK COMBO		272 KG (600 LBS)	3075	3X 91CM	365	445	405	
G-MAX PLATE SQUARE QUAD-STACK COMBO	360 KG (800 LBS)	4100	4X 91CM	365	445	405		

* Tuuci advises to use G-MAX plate 270kg square for 400cm square cantilevers in combination with wheels

Half aluma-crete cube anchors are of galvanized steel frame, stone pavers and with stainless steel security sleeve.
Stainless steel security sleeve & beauty cover ship with all MAX parasols.

	HALF ALUMA-CRETE CUBE ANCHOR 115 X 68 X 27 CM	FRAME, 6 PAVERS & WHITE COVER 236 KG (520.5 LBS)	1985
		FRAME, 8 PAVERS & WHITE COVER 296 KG (652.5 LBS)	2155
		FRAME, 8 PAVERS, 2 GVS PLATES & WHITE COVER 351 KG (773 LBS)	2685

IN GROUND & ACCESSORIES

	MAX IN-GROUND SECURITY MOUNT	FOR USE IN NEW POUR CONCRETE FOR USE WITH ALL MAX BASE STEMS	670
	TUFF WHEELS FOR G-PLATE ANCHORS	FOR USE WITH GALVANIZED STEEL SQUARE ANCHORS *TUUCI ADVISES TO USE G-MAX PLATE 270KG SQUARE FOR 400CM SQUARE CANTILEVERS IN COMBINATION WITH WHEELS	405
	STAINLESS STEEL BOTTOM PLATE	FOR USE ON EXISTING CONCRETE PAD INCLUDES 8 DROP-IN EXPANSION ANCHORS FOR USE WITH ALL MAX BASE STEMS	895
	STAINLESS STEEL EXTENSION	FOR USE WITH ALL MAX BASE STEMS SPECIFY SIZE BETWEEN 2"-20" / 5-51 CM LONGER LEADTIME PRICE: 750 XPRESS PRICE: 950	950

Galvanized steel (GVS) bases are an industrial strength product and have uneven color and finish when new. After a short period of exposure to weather, the finish will have an even & neat galvanized silver appearance.

PRODUCT ANATOMY

OCEAN MASTER





CENTER POST



PRODUCT OVERVIEW & PRICING

OCEAN MASTER MEGA MAX CLASSIC



Tuuci's Ocean Master MEGA MAX parasol is a statement piece intended to suit all large outdoor shade needs. Design and engineering meet to produce an elegant profile with robust construction created to withstand high winds up to 70 kmh / 45mph sustained and gusts up to 120 kmh/ 75 mph depending on anchor/fixation. The strength, durability and serviceable design allows for an extended usable life reducing the environmental impact of the product. **Standard features include:** security stem, polished stainless steel hub, polished MAX acorn finial. *May not close over table.*

OCEAN MASTER MEGA MAX CLASSIC				STANDARD INCLUDED					FINISH UPGRADE	CANOPY ENHANCEMENT				ANCHOR
				FABRIC	VENT	PROFILE	LIFT	FINISH		2810	990	1035	2445	
		MAST DIAMETER	LIST PRICE EUR	MARINE MXT 9700 SERIES	SINGLE WIND VENT (MATCHING STANDARD, CONTRASTING OPTION)	MARKET CUT PROFILE	EASYDRIVE CRANK LIFT	POWDER COAT OPTIONS SEE PAGE 23 FOR DETAILS	PLANTATION ALUMA-TEAK™ OPTIONS SEE PAGE 23 FOR DETAILS	CONTRASTING BINDING (CANOPY AND VENT)	25CM ACCENT BORDER ON CANOPY	VALANCE (STRAIGHT, SCALLOPED, CLASSIC OR MODERN ROMAN)	15CM CORD FRINGE	MINIMUM RECOMMENDED WEIGHT
SQUARE			LEVEL C							PP. 142-143 FOR MORE ENHANCEMENTS				
OMMX16SQ	16.0' / 4.9m	133mm	17315	INCL	INCL	INCL	INCL	INCL	o	o	o	o	o	440KG
OMMX18SQ	18.0' / 5.5m	133mm	18360	INCL	INCL	INCL	INCL	INCL	o	o	o	o	o	440KG
OMMX20SQ	20.0' / 6m	133mm	19395	INCL	INCL	INCL	INCL	INCL	o	o	o	o	o	440KG
OMMX24SQ	24.0' / 7.3m	133mm	21475	INCL	INCL	INCL	INCL	INCL	o	o	o	o	o	550KG
ROUND			LEVEL C							PP. 142-143 FOR MORE ENHANCEMENTS				
OMMX16RND	16.0' / 4.9m	133mm	16635	INCL	INCL	INCL	INCL	INCL	o	o	o	o	o	440KG
OMMX20RND	20.0' / 6m	133mm	18715	INCL	INCL	INCL	INCL	INCL	o	o	o	o	o	440KG
OMMX24RND	24.0' / 7.3m	133mm	20795	INCL	INCL	INCL	INCL	INCL	o	o	o	o	o	550KG
RECTANGLE			LEVEL C							PP. 142-143 FOR MORE ENHANCEMENTS				
OMMX14X20RECT	14.0' x 20.0' / 4.25m x 6m	133mm	17630	INCL	INCL	INCL	INCL	INCL	o	o	o	o	o	440KG
OMMX16X24RECT	16.0' x 24.0' / 4.9m x 7.3m	133mm	19710	INCL	INCL	INCL	INCL	INCL	o	o	o	o	o	440KG
OMMX18X24RECT	18.0' x 24.0' / 5.5m x 7.3m	133mm	20750	INCL	INCL	INCL	INCL	INCL	o	o	o	o	o	550KG

PRODUCT UPGRADES

AMBIATM LED LIGHT AND HEATING (220V)

The Ambia™ LED Light for the Ocean Master MEGA MAX has two lightning elements, one that illuminates ambient light upward into the canopy and a second that directs light downward. Both lights can be operated separately and offer variable settings. Please note that lighter canopy fabric colors reflect the light more efficiently than darker colors. Battery Power Pack for Ambia LED Light only.

AVAILABLE ON OCEAN MASTER MEGA MAX CENTER POST				
STANDARD POWER	BATTERY POWER	9540	12610	
2125	3350			
<p>AMBIA LED LIGHT</p>  <p>Independent up and down dimming</p>	<p>AMBIA LED LIGHT AND 4 HEATERS <i>Indicate white or black heaters (220V required)</i></p> <p>Power on/off</p>  <p>Independent up and down dimming</p> <p>Heater</p>	<p>AMBIA LED LIGHT AND 6 HEATERS <i>Indicate white or black heaters (220V required)</i></p> <p>Power on/off</p>  <p>Independent up and down dimming</p> <p>Heater</p>		
<p>BATTERY OPTIONS <i>Indicate US, European or Asia.</i></p>		<p>ADDITIONAL SINGLE BATTERY 275 NET</p>	<p>ADDITIONAL SINGLE BAY CHARGER <i>(charges 1 battery)</i> 250 NET</p>	<p>ADDITIONAL QUAD BAY CHARGER <i>(charges 4 batteries)</i> 850 NET</p>

AMBIATM LED LIGHTS

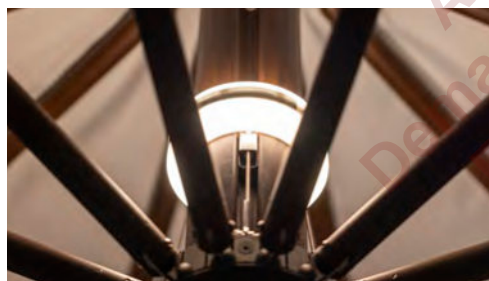

BATTERY



HEATING



HEATER POSITIONS

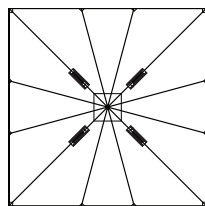

Square 4 Heaters

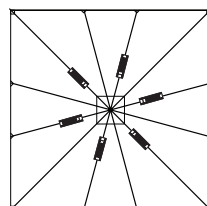

Square 6 Heaters

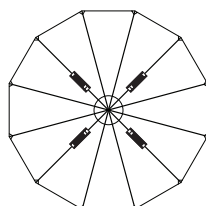

Round 4 Heaters

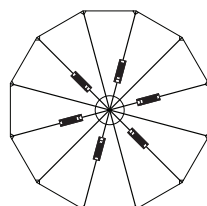

Round 6 Heaters

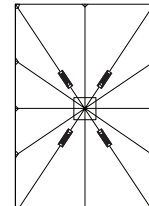

Rectangle 4 Heaters

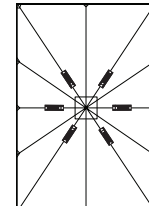

Rectangle 6 Heaters

Select lighting and heating options when placing your order. These options cannot be retrofitted to existing parasols. Lights and heaters will be pre-installed at the factory and shipped with the parasol. External AC (110V or 240V) comes out of the bottom of the mast with a set 10' cord and plug. The customer is responsible for the onsite connection, and can either remove the plug and hardwire or adapt the plug to accommodate the various configurations by country. Lighting meets the applicable UL Codes in the US and CE codes in Europe. Approvals are pending. This electrical system is not UL rated.

The Ambia™ LED Light is bright enough for commercial settings. Low voltage -- direct current 12 volts. The temperature range is 2700K to 2900K.

Features of the heating device: Safe, maintenance free, odorless infrared heating element rated for outdoor/indoor areas. Adjustable bracket for easy orientation and auto switch to turn device off when umbrella is closed. Scratch resistant, sleek aluminum fixture, with hard-wearing finish available in black or white. UL Certified and operates for as little as 0.20 per hour.

Heating requires 220V and may require an electrician to modify standard outlet to accommodate.

ABOVE GROUND SHADE ANCHORS OVERVIEW & PRICING

FULL ALUMA-CRETE CUBE ANCHOR

ALL MEGA MAX PARASOLS SHIP WITH STAINLESS STEEL SECURITY STEM & BEAUTY COVER. PLEASE INDICATE ELECTRICAL OPTIONS. SUITABLE FOR WINDS UP TO 40 KM/H / 25 MPH. CLOSE WHEN NOT IN USE, DURING STORMS, AND AT NIGHT. TOLERANCES +/- 4.5KG / 10 LBS

FULL ALUMA-CRETE CUBE ANCHOR		FINISH	FINISH UPGRADE	
 <p>L: 116cm W: 116cm H: 20cm</p> <p>COMPLETE ASSEMBLY; FULL FRAME, PAVERS & COVER</p>		POWDER COAT OPTIONS SEE PAGE 22	PLANTATION ALUMA-TEAK SEE PAGE 22	
AGSP-MMX	385KG / 845 LBS - 8 PAVERS. FOR USE WITH 16SQ OR 16RND.	2815	INCL	600
AGSP-MMX	500 KG / 1100 LBS - 12 PAVERS. FOR USE WITH 18SQ, 20RND OR SMALLER.	3380	INCL	600
AGSP-MMX	620 KG / 1365 LBS - 12 PAVERS & 4 GVS PLATES. FOR USE WITH 20SQ, 24RND, 14X20RECT OR SMALLER.	4110	INCL	600
AGSP-MMX	855 KG / 1885 LBS - 10 PAVERS & 14 GVS PLATES. FOR USE WITH 24SQ, 16X24RECT, 18X24RECT OR SMALLER.	5885	INCL	600

FULL CUBE CUSHION



UPHOLSTERED OPEN CELL FOAM. INDICATE ELECTRICAL OPTIONS

FULL CUBE CUSHION		FABRIC	FABRIC UPGRADE		
 <p>L: 116cm W: 116cm H: 20cm</p>		CXT & LXT SERIES. LEVEL B SEE PAGE 133 FOR DETAILS	ALL PXT SERIES. LEVEL C SEE PAGE 133 FOR DETAILS		
AGSP-FCC	FULL CUBE CUSHION ONLY	2350	INCL	INCL	20%

IN GROUND SHADE ANCHORS OVERVIEW & PRICING

STAINLESS STEEL HINGED SURFACE ANCHOR

PREFERRED ANCHORING SYSTEM. MEGA MAX PARASOLS SHIP WITH STAINLESS STEEL SECURITY STEM AND BEAUTY COVER. CONCRETE TYPE: 4000 PSI REINFORCED WITH NUMBER 5 REBAR, SPACED 30,5CM / 12" ON CENTER, ON BOTH THE TOP AND BOTTOM FACES, AND ORIENTED IN BOTH THE LONGITUDINAL AND TRANSVERSE DIRECTIONS.

STAINLESS STEEL HINGED SURFACE ANCHOR		STANDARD INCLUDED		
 <p>(NP)</p>	 <p>(EC)</p>	<p>INCLUDES 4-7-BOLTS MAX. WIND LOAD 70 KM/H / 45 MPH. 3 SECOND WIND GUSTS UP TO 120 KM/H / 75 MPH</p>		
MEGAMAXPLATE-NP	FOR USE IN NEW POUR CONCRETE.	1550	INCL	—
MEGAMAXPLATE-EC	FOR USE ON EXISTING CONCRETE PAD	1550	—	INCL

SHADE ANCHORS

FINISHES

Plantation Aluma-TEAK™



Powder coat

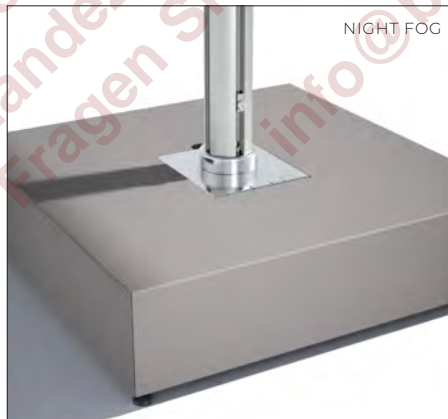

PRODUCT ANATOMY



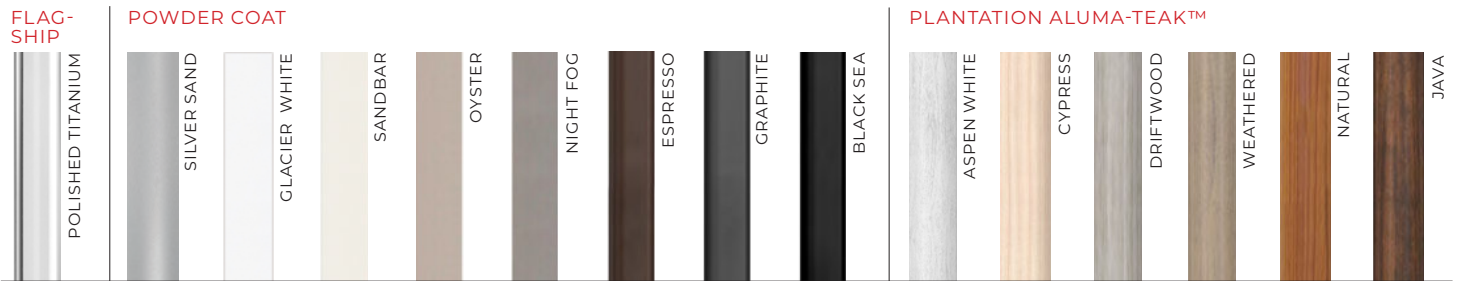

OCEAN MASTER CENTER POST



PRODUCT OVERVIEW & PRICING

OCEAN MASTER MAX CLASSIC

The Ocean Master MAX classic parasol offers expansive shade, profound strength, and reinforced shade skins all while maintaining its traditional yet minimalistic design. Classic European tailoring paired with the innovative V-MAX™ Strut Design makes the Ocean Master MAX Classic parasol perfect for luxurious beachfront properties. **Standard features include:** security stem, polished titanium hub & polished MAX acorn finial. *May not close over table.* Additional mast length €345, specify 10, 20, 30cm, not available with heating and lighting.



OCEAN MASTER MAX CLASSIC			STANDARD INCLUDED							FINISH UPGRADE		LIFT UPGRADE	MAST UPGRADE	CANOPY ENHANCEMENT				COVER BAG	ANCHOR	
			FABRIC	VENT	PROFILE	LIFT		FINISH	655	1610	1330	680	280	680	680	910	720	WEIGHT		
		MAST DIAMETER	LIST PRICE EUR	ALL MXT SERIES, SEE PAGE 133 FOR DETAILS & OTHER OPTIONS.							POWDER COAT OPTIONS SEE PAGE 29 FOR DETAILS		EASYDRIVE CRANK LIFT (+TELESCOPING MAST)	NORTHSTAR MAST - SEE PAGE 147 FOR DETAILS (NOT AVAILABLE WITH LIGHT OR HEATERS)	CONTRASTING BINDING (CANOPY AND VENT) 15CM ACCENT BORDER ON CANOPY VALANCE (STRAIGHT, SCALLOPED, CLASSIC OR MODERN ROMAN) 15CM CORD FRINGE				CUSTOM PROTECTIVE COVER	MINIMUM RECOMMENDED WEIGHT
SQUARE			LEVEL C												PP. 142-143 FOR MORE ENHANCEMENTS					
OMX8SQ	8.0' / 2.45m	60mm	4110	INCL	INCL	INCL	INCL	—	INCL	o	o	o	o	o	o	o	o	CX2	90KG	
OMX10SQ	10.0' / 3.0m	60mm	5150	INCL	INCL	INCL	INCL	—	INCL	o	o	o	o	o	o	o	o	CX2	90KG	
OMX12SQ	12.0' / 3.65m	73mm	7540	INCL	INCL	INCL	—	INCL	INCL	o	o	—	o	o	o	o	o	CX4	127KG	
OMX14SQ	14.0' / 4.25m	73mm	8790	INCL	INCL	INCL	—	INCL	INCL	o	o	—	o	o	o	o	o	CX5	180KG	
OMX16SQ	16.0' / 4.9m	73mm	10140	INCL	INCL	INCL	—	INCL	INCL	o	o	—	o	o	o	o	o	CX5	180KG	
OCTAGON			LEVEL C												PP. 142-143 FOR MORE ENHANCEMENTS					
OMX9OCT	9.0' / 2.75m	60mm	3485	INCL	INCL	INCL	INCL	—	INCL	o	o	o	o	o	o	o	o	CX2	90KG	
OMX11OCT	11.0' / 3.4m	60mm	4265	INCL	INCL	INCL	INCL	—	INCL	o	o	o	o	o	o	o	o	CX2	90KG	
OMX13OCT	13.0' / 4.0m	73mm	6500	INCL	INCL	INCL	—	INCL	INCL	o	o	—	o	o	o	o	o	CX2	127KG	
OMX15OCT	15.0' / 4.5m	73mm	8110	INCL	INCL	INCL	—	INCL	INCL	o	o	—	o	o	o	o	o	CX2	180KG	
OMX17OCT	17.0' / 5.2m	73mm	9830	INCL	INCL	INCL	—	INCL	INCL	o	o	—	o	o	o	o	o	CX4	180KG	
RECTANGLE			LEVEL C												PP. 142-143 FOR MORE ENHANCEMENTS					
OMX8X12RECT	8.0' x 12.0' / 2.45m x 3.65m	60mm	5200	INCL	INCL	INCL	INCL	—	INCL	o	o	o	o	o	o	o	o	CX2	90KG	
OMX10X14RECT	10.0' x 14.0' / 3.0m x 4.25m	73mm	8060	INCL	INCL	INCL	—	INCL	INCL	o	o	—	o	o	o	o	o	CX4	180KG	
OMX12X16RECT	12.0' x 16.0' / 3.65m x 4.9m	73mm	9255	INCL	INCL	INCL	—	INCL	INCL	o	o	—	o	o	o	o	o	CX5	180KG	

o These masts are not telescopic but will close above table height.

PRODUCT OVERVIEW & PRICING



OCEAN MASTER MAX MANTA

The boundaries of shade architecture have been redefined with the Ocean Master MAX Manta parasol. Inspired from deep beneath the sea, the Manta MAX takes beautiful flight above any seascape. An open air living space has never known the tranquil comfort of this awesome and imaginative shade platform. **Standard features include:** non-vented fishtail canopy, security stem, polished titanium hub & polished MAX acorn finial. *May not close over table.* Additional mast length €345, specify 10, 20, 30cm.

OCEAN MASTER MAX MANTA				STANDARD INCLUDED				FINISH UPGRADE		LIFT UPGRADE	MAST UPGRADE	CANOPY ENHANCEMENT			COVER BAG	ANCHOR
				FABRIC	PROFILE	LIFT		FINISH	655	1610	1330	680	280	680	910	720
		MAST DIAMETER	LIST PRICE EUR	ALL MXT SERIES. SEE PAGE 133 FOR DETAILS & OTHER OPTIONS.				POWDER COAT OPTIONS SEE PAGE 29 FOR DETAILS		EASYDRIVE CRANK LIFT W/ TELESCOPING MAST	NORTHSTAR MAST - SEE PAGE 147 FOR DETAILS (NOT AVAILABLE WITH LIGHT OR HEATERS)	CONTRASTING BINDING ON CANOPY	15CM ACCENT BORDER ON CANOPY	15CM CORD FRINGE	CUSTOM PROTECTIVE COVER	MINIMUM RECOMMENDED WEIGHT
				FISHTAIL PROFILE, INCLUDES CANOPY BINDING (MATCHING STANDARD, CONTRASTING OPTION)	AUTO-LOC MARINE PULLEY LIFT	EASYDRIVE CRANK LIFT W/ TELESCOPING MAST	POLISHED TITANIUM	PLANTATION ALUMA-TEAK™ OPTIONS SEE PAGE 29 FOR DETAILS								
SQUARE			LEVEL C									PP. 142-143 FOR MORE ENHANCEMENTS				
OMXM10SQ	10.0' / 3.0m	60mm	5825	INCL	INCL	INCL	—	INCL	o	o	o	o	o	o	CX2	90KG
OMXM14SQ	14.0' / 4.25m	73mm	10295	INCL	INCL	—	INCL	INCL	o	o	—	o	o	o	CX5	180KG

OCEAN MASTER MAX ZERO HORIZON



Posing no intrusion to the eye or to Nature's wondrous beauty, the Ocean Master MAX Zero Horizon parasol is a triumph of minimalistic design and ultimate shade functionality. **Standard features include:** non-vented canopy, security stem, polished titanium hub & polished MAX acorn finial. *May not close over table.* Additional mast length €345, specify 10, 20, 30cm. Not available with heating and lighting.

OCEAN MASTER MAX ZERO HORIZON				STANDARD INCLUDED				FINISH UPGRADE		LIFT UPGRADE	MAST UPGRADE	CANOPY ENHANCEMENT			COVER BAG	ANCHOR
				FABRIC	PROFILE	LIFT		FINISH	655	1610	1330	680	280	680	910	720
		MAST DIAMETER	LIST PRICE EUR	ALL MXT SERIES. SEE PAGE 133 FOR DETAILS & OTHER OPTIONS.				POWDER COAT OPTIONS SEE PAGE 29 FOR DETAILS		EASYDRIVE CRANK LIFT W/ TELESCOPING MAST	NORTHSTAR MAST - SEE PAGE 147 FOR DETAILS (NOT AVAILABLE WITH LIGHT OR HEATERS)	CONTRASTING BINDING ON CANOPY	15CM ACCENT BORDER ON CANOPY	15CM CORD FRINGE	CUSTOM PROTECTIVE COVER	MINIMUM RECOMMENDED WEIGHT
				MARKET CUT PROFILE	AUTO-LOC MARINE PULLEY LIFT	EASYDRIVE CRANK LIFT W/ TELESCOPING MAST	POLISHED TITANIUM	PLANTATION ALUMA-TEAK™ OPTIONS SEE PAGE 29 FOR DETAILS								
SQUARE			LEVEL C									PP. 142-143 FOR MORE ENHANCEMENTS				
OMXZ10SQ	10.0' / 3.0m	60mm	5825	INCL	INCL	INCL	—	INCL	o	o	o	o	o	o	CX2	90KG
OMXZ14SQ	14.0' / 4.25m	73mm	10295	INCL	INCL	—	INCL	INCL	o	o	—	o	o	o	CX5	180KG
OCTAGON			LEVEL C									PP. 142-143 FOR MORE ENHANCEMENTS				
OMXZ12OCT	12.0' / 3.65m	60mm	5930	INCL	INCL	INCL	—	INCL	o	o	o	o	o	o	CX2	90KG
OMXZ16OCT	16.0' / 4.9m	73mm	10660	INCL	INCL	—	INCL	INCL	o	o	—	o	o	o	CX4	180KG

PRODUCT OVERVIEW & PRICING



OCEAN MASTER MAX CRESCENT

Sweeping curves of the Ocean Master MAX Crescent parasol capture the eye and reach further than ever before with Tuuci's exclusive "V-MAX"™ strut design. This contemporary interpretation of a classic French Riviera outdoor parasol is highlighted with high polished finial and classic Tuuci canopy tailoring to create a luxurious shade oasis in any environment. **Standard features include:** non-vented fishtail canopy, security stem, polished titanium hub & polished MAX acorn finial. *May not close over table.* Additional mast length €345, specify 10, 20, 30cm.

OCEAN MASTER MAX CRESCENT				STANDARD INCLUDED					FINISH UPGRADE		LIFT UPGRADE	MAST UPGRADE	CANOPY ENHANCEMENT			COVER BAG	ANCHOR		
				FABRIC	PROFILE	LIFT	FINISH		655	1610	1330	680	280	680	910	720	WEIGHT		
		MAST DIAMETER	LIST PRICE EUR	ALL MXT SERIES, SEE PAGE 133 FOR DETAILS & OTHER OPTIONS.		FISHTAIL PROFILE; INCLUDES CANOPY BINDING (MATCHING STANDARD, CONTRASTING OPTION)	AUTO-LOC MARINE PULLEY LIFT	EASYDRIVE CRANK LIFT W/ TELESCOPING MAST	POLISHED TITANIUM		POWDER COAT OPTIONS SEE PAGE 29 FOR DETAILS	PLANTATION ALUMA-TEAK™ OPTIONS SEE PAGE 29 FOR DETAILS	EASYDRIVE CRANK LIFT W/ TELESCOPING MAST	NORTHSTAR MAST - SEE PAGE 142 FOR DETAILS (NOT AVAILABLE WITH LIGHT FOR HEATERS)	CONTRASTING BINDING ON CANOPY	15CM ACCENT BORDER AND ACCENT CAP	15CM CORD FRINGE	CUSTOM PROTECTIVE COVER	MINIMUM RECOMMENDED WEIGHT
OCTAGON			LEVEL C									PP. 142-143 FOR MORE ENHANCEMENTS							
OMXC14OCT	14.0' / 4.25m	60mm	7905	INCL	INCL	INCL	—	INCL	o	o	o	o	o	o	o	o	CX2	127KG	
OMXC16OCT	16.0' / 4.9m	73mm	11325	INCL	INCL	—	INCL	INCL	o	—	—	o	o	o	o	o	CX4	180KG	
OMXC18OCT	18.0' / 5.5m	73mm	14040	INCL	INCL	—	INCL	INCL	o	—	—	o	o	o	o	o	CX4	180KG	

OCEAN MASTER MAX F-1

Tuuci's most durable and wind-resistant design is the F-1. Featuring high-tension stainless steel reinforcement cables, Armor-Wall-Aluminum Construction and tensioned stainless steel pocket construction, this parasol is built to withstand wind gusts up to 70 km/h. **Standard features include:** non-vented fishtail canopy, security stem, polished titanium hub & polished MAX acorn finial.

OCEAN MASTER MAX F-1				STANDARD INCLUDED					FINISH UPGRADE		ANCHOR	
				FABRIC	ACCENT BORDER/CAP	PROFILE	LIFT	FINISH	655	1610	WEIGHT	
		MAST DIAMETER	LIST PRICE EUR	PREMIER PXT SERIES	25CM ACCENT BORDER ON CANOPY OR ACCENT CAP. AVAILABLE IN MXT 9000-9600 OR MXT 9700 SERIES. SEE PAGE 133 FOR DETAILS & OTHER OPTIONS.	FISHTAIL PROFILE; INCLUDES CANOPY BINDING (MATCHING STANDARD, CONTRASTING OPTION)	EASYDRIVE CRANK LIFT W/ TELESCOPING MAST	POLISHED TITANIUM		POWDER COAT OPTIONS SEE PAGE 29 FOR DETAILS	PLANTATION ALUMA-TEAK™ OPTIONS SEE PAGE 29 FOR DETAILS	MINIMUM RECOMMENDED WEIGHT
SQUARE			LEVEL E	LEVEL C								
F1OMX13.OSQ	13.0' / 4.0m	73mm	11595	INCL	INCL	INCL	INCL	INCL	o	o		270KG
OCTAGON			LEVEL E	LEVEL C								
F1OMX18.OOCT	18.0' / 5.5m	73mm	14405	INCL	INCL	INCL	INCL	INCL	o	o		270KG

PRODUCT ANATOMY

OCEAN MASTER



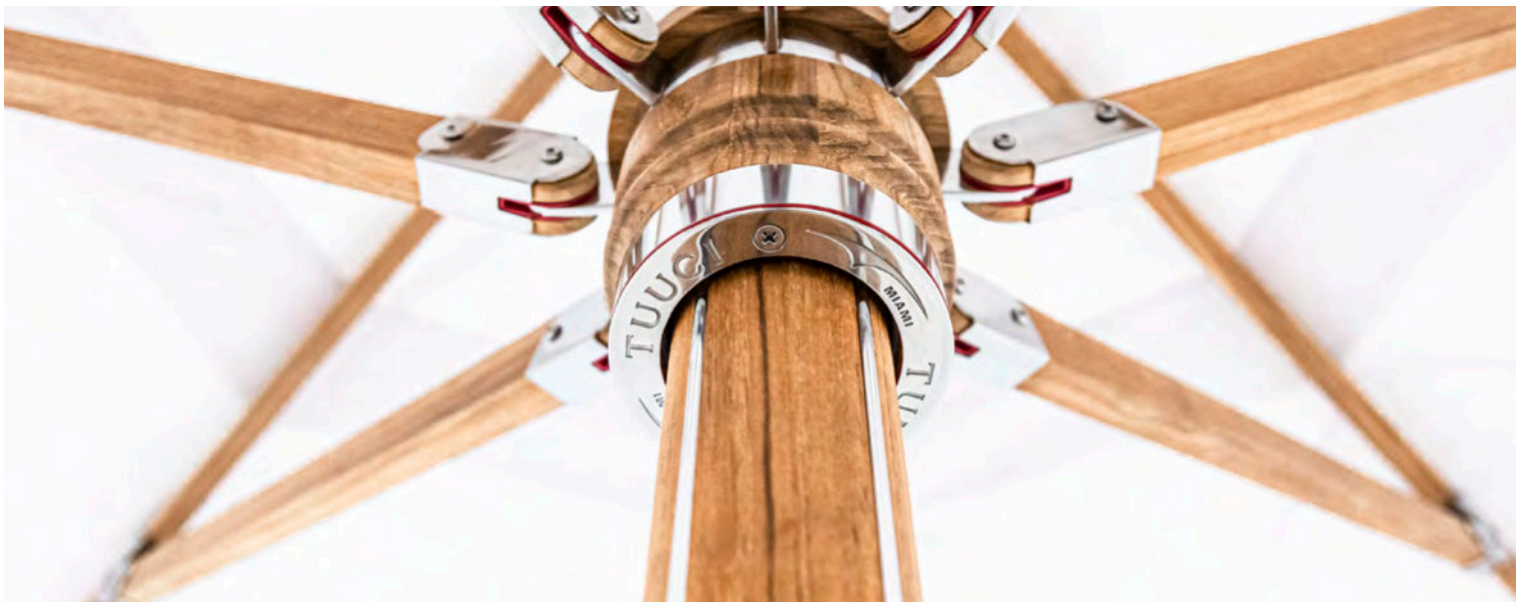
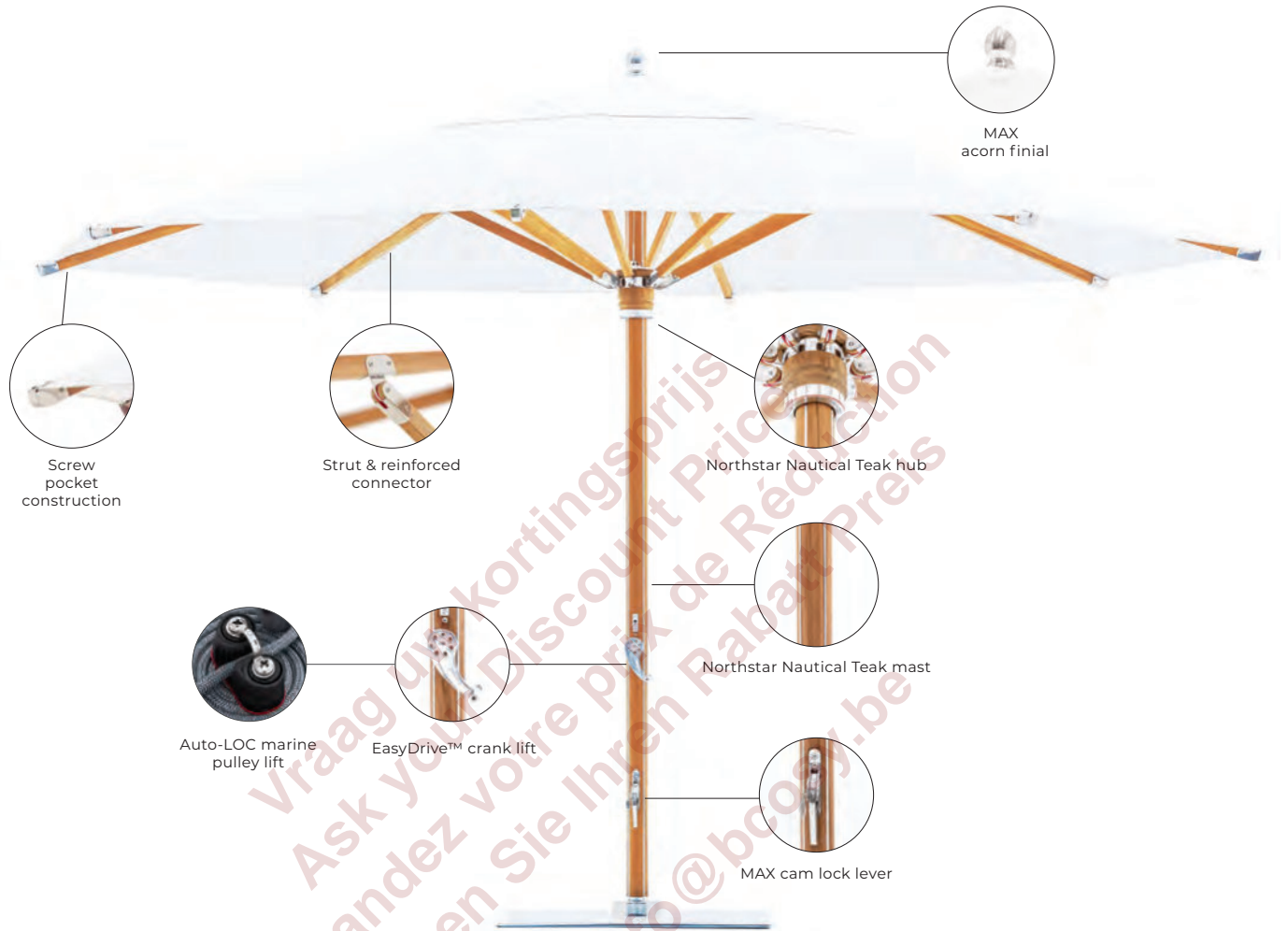

NORTHSTAR NAUTICAL TEAK



PRODUCT OVERVIEW & PRICING

OCEAN MASTER MAX NORTHSTAR NAUTICAL TEAK

Drawing inspiration from classic and modern sailing architecture and details, this innovative design sets a new standard for teak parasols. The Ocean Master MAX Northstar Nautical Teak is a refined vision of timelessness, featuring brilliantly polished ridges combined with the elegant beauty of natural wood that continues to perform over time. **Standard features include:** security stem, Nautical Teak hub, mast, ribs and struts & polished MAX acorn finial. *May not close over table.*

OCEAN MASTER MAX NORTHSTAR NAUTICAL TEAK				STANDARD INCLUDED						CANOPY ENHANCEMENT				COVER BAG	ANCHOR
				FABRIC	VENT	PROFILE	LIFT		FINISH	280	680	680	910	720	WEIGHT
		MAST DIAMETER	LIST PRICE EUR	ALL MXT SERIES, SEE PAGE 133 FOR DETAILS & OTHER OPTIONS.	SINGLE WIND VENT (MATCHING STANDARD, CONTRASTING OPTION)	MARKET CUT PROFILE WITH BINDING (MATCHING STANDARD, CONTRASTING OPTION)	AUTO-LOC MARINE PULLEY LIFT	EASYDRIVE CRANK LIFT W/ TELESCOPING MAST	NATURAL	CONTRASTING BINDING ON CANOPY & VENT	15CM ACCENT BORDER ON CANOPY	VALANCE (STRAIGHT, SCALLOPED, CLASSIC OR MODERN ROMAN)	15CM CORD FRINGE	CUSTOM PROTECTIVE COVER	MINIMUM RECOMMENDED WEIGHT
SQUARE			LEVEL C	PP. 142-143 FOR MORE ENHANCEMENTS						PP. 142-143 FOR MORE ENHANCEMENTS					
NSTK6.5SQ	6.5' / 2.0m	76.2mm	6010	INCL	INCL	INCL	INCL	—	INCL	o	o	o	o	CX1	64KG
NSTK8SQ	8.0' / 2.45m	76.2mm	8005	INCL	INCL	INCL	INCL	—	INCL	o	o	o	o	CX1	90KG
NSTK10SQ	10.0' / 3.0m	76.2mm	11330	INCL	INCL	INCL	—	INCL	INCL	o	o	o	o	CX2	90KG
OCTAGON			LEVEL C	PP. 142-143 FOR MORE ENHANCEMENTS						PP. 142-143 FOR MORE ENHANCEMENTS					
NSTK9OCT	9.0' / 2.75m	76.2mm	8005	INCL	INCL	INCL	INCL	—	INCL	o	o	o	o	CX1	90KG
NSTK11OCT	11.0' / 3.4m	76.2mm	9670	INCL	INCL	INCL	INCL	—	INCL	o	o	o	o	CX2	90KG
NSTK13OCT	13.0' / 4.0m	76.2mm	11665	INCL	INCL	INCL	—	INCL	INCL	o	o	o	o	CX2	127KG
RECTANGLE			LEVEL C	PP. 142-143 FOR MORE ENHANCEMENTS						PP. 142-143 FOR MORE ENHANCEMENTS					
NSTK8X12RECT	8.0' X 12.0' / 2.45 X 3.65m	76.2mm	11665	INCL	INCL	INCL	—	INCL	INCL	o	o	o	o	CX2	90KG

PRODUCT ANATOMY

OCEAN MASTER





NAUTICAL TEAK



PRODUCT OVERVIEW & PRICING

OCEAN MASTER MAX NAUTICAL TEAK

Drawing inspiration from classic and modern sailing architecture and details, this innovative design sets a new standard for teak parasols. A uniquely reinforced mast sports an aluminum spine, adding strength while also affording the integration of an internal telescoping crank lift system, something never before achieved on a teak parasol. **Standard features include:** security sleeve on 60mm mast and security stem on 76.2mm mast, Nautical Teak hub, mast, ribs and struts & polished MAX acorn finial. *May not close over table.*

OCEAN MASTER MAX NAUTICAL TEAK				STANDARD INCLUDED						CANOPY ENHANCEMENT				COVER BAG	ANCHOR	
				FABRIC	VENT	PROFILE	LIFT		FINISH	280	680	680	910	720	WEIGHT	
		MAST DIAMETER	LIST PRICE EUR	ALL MXT SERIES. SEE PAGE 133 FOR DETAILS & OTHER OPTIONS.						CONTRASTING BINDING ON CANOPY & VENT				CUSTOM PROTECTIVE COVER	MINIMUM RECOMMENDED WEIGHT	
				SINGLE WIND VENT (MATCHING STANDARD, CONTRASTING OPTION)	MARKET CUT PROFILE WITH BINDING (MATCHING STANDARD, CONTRASTING OPTION)		AUTO-LOC MARINE PULLEY LIFT		EASYDRIVE CRANK LIFT W/ TELESCOPING MAST	NATURAL	15CM ACCENT BORDER ON CANOPY					
				VALANCE (STRAIGHT, SCALLOPED, CLASSIC OR MODERN ROMAN)						15CM CORD FRINGE						
SQUARE			LEVEL C	PP. 142-143 FOR MORE ENHANCEMENTS												
TKX6.5SQ	6.5' / 2.0m	60mm	5330	INCL	INCL	INCL	INCL	—	INCL	o	o	o	o	CX1	64KG	
TKX8SQ	8.0' / 2.45m	60mm	7320	INCL	INCL	INCL	INCL	—	INCL	o	o	o	o	CX1	90KG	
TKX10SQ	10.0' / 3.0m	76.2mm	10650	INCL	INCL	INCL	—	INCL	INCL	o	o	o	o	CX2	90KG	
OCTAGON			LEVEL C	PP. 142-143 FOR MORE ENHANCEMENTS												
TKX9OCT	9.0' / 2.75m	60mm	7320	INCL	INCL	INCL	INCL	—	INCL	o	o	o	o	CX1	90KG	
TKX11.5OCT	11.0' / 3.4m	60mm	8990	INCL	INCL	INCL	INCL	—	INCL	o	o	o	o	CX2	90KG	
TKX13OCT	13.0' / 4.0m	76.2mm	10980	INCL	INCL	INCL	—	INCL	INCL	o	o	o	o	CX2	127KG	
RECTANGLE			LEVEL C	PP. 142-143 FOR MORE ENHANCEMENTS												
TKX8X12RECT	8.0' X 12.0' / 2.45 X 3.65m	76.2mm	10980	INCL	INCL	INCL	—	INCL	INCL	o	o	o	o	CX2	90KG	

PRODUCT UPGRADES

AMBIATM LED LIGHT AND HEATING (220V)

The Ambia™ LED Light is an ambient light that illuminates upward into the canopy. Please note that lighter canopy fabric colors reflect the light more efficiently than darker colors. Battery power pack for Ambia LED Light only.

Not compatible with the AGSP or AGSP2 Aluma-Crete Cube Above Ground Anchors.

ONLY AVAILABLE ON OCEAN MASTER MAX CLASSIC, MANTA AND CRESCENT PARASOLS				
STANDARD POWER	BATTERY POWER	5455		8800
1105	1725			
<p>AMBIA LED LIGHT (220V required)</p>  <p>On/off only EasyDrive crank lift system</p>	<p>AMBIA LED LIGHT</p>  <p>Independent up dimming</p>	<p>AMBIA LED LIGHT AND 2 HEATERS EasyDrive crank lift Indicate white or black heaters (220V required)</p> <p>Power on/off</p>  <p>Ambia LED light On/off only, no dimming</p> <p>Heater</p>	<p>AMBIA LED LIGHT AND 4 HEATERS EasyDrive crank lift Indicate white or black heaters (220V required)</p> <p>Power on/off</p>  <p>Ambia LED light On/off only, no dimming</p> <p>Heater</p>	
<p>BATTERY OPTIONS Indicate US, European or Asia.</p>		<p>ADDITIONAL BATTERY</p> <p>275 NET</p>	<p>ADDITIONAL SINGLE BAY CHARGER (charges 1 battery)</p> <p>250 NET</p>	<p>ADDITIONAL QUAD BAY CHARGER (charges 4 batteries)</p> <p>850 NET</p>

AMBIATM LED LIGHT



BATTERY



HEATING



Select lighting and heating options when placing your order. These options cannot be retrofitted to existing parasols. Lights and heaters will be pre-installed at the factory and shipped with the parasol. External AC (110V or 240V) comes out of the bottom of the mast with a set 10' cord and plug. The customer is responsible for the onsite connection, and can either remove the plug and hardwire or adapt the plug to accommodate the various configurations by country. Lighting meets the applicable UL Codes in the US and CE codes in Europe. Approvals are pending. This electrical system is not UL rated.

The Ambia™ LED Light is bright enough for commercial settings. Low voltage -- direct current 12 volts. The temperature range is 2700K to 2900K.

Features of the heating device: Safe, maintenance free, odorless infrared heating element rated for outdoor/indoor areas. Adjustable bracket for easy orientation and auto switch to turn device off when umbrella is closed. Scratch resistant, sleek aluminum fixture, with hard-wearing finish available in black or white. UL Certified and operates for as little as 0.20 per hour.

Heating requires 220V and may require an electrician to modify standard outlet to accommodate.

ABOVE GROUND SHADE ANCHORS OVERVIEW & PRICING

ALUMA-CRETE ROUND

ALUMINIUM, CONCRETE FILLED, FOUR HOLE VERSION.

NOT RECOMMENDED FOR USE WITH PARASOLS LARGER THAN 10' / 3M SQ. 13' / 4M OCT OR 8'X12' / 2.45X3.65M RECT.
ALL MAX PARASOLS SHIP WITH STAINLESS STEEL SECURITY STEM & BEAUTY COVER. TOLERANCES +/- 4.5 KG / 10 LBS

ALUMA-CRETE ROUND ANCHORS		FINISH	FINISH UPGRADE	
		LIST PRICE EUR POWDER COAT OPTIONS: SEE PAGE 39	PLANTATION ALUMA-TEAK. SEE PAGE 39	
ACF200	86 KG / 200 LBS. 76CM / 30.0" DIAMETER	820	INCL	230
ACF250	109 KG / 250 LBS. 84CM / 33.0" DIAMETER	930	INCL	230

G-MAX PLATE ANCHORS

GALVANIZED STEEL WITH STAINLESS STEEL SECURITY STEM.

ALL MAX PARASOLS SHIP WITH STAINLESS STEEL SECURITY STEM & BEAUTY COVER. TOLERANCES +/- 4.5 KG / 10 LBS

G-PLATE ANCHORS		FINISH	ANCHOR COVERS (TOP G-PLATE ONLY)		TUFF WHEELS	
		LIST PRICE EUR GALVANIZED STEEL	POWDER COAT OPTIONS SEE PAGE 39 MARINE SILVER NOT AVAILABLE	PLANTATION ALUMA-TEAK SEE PAGE 39	1 SET OF 4 WHEELS	
GV30SQ	64 KG / 135 LBS. 76CM / 30.0" SQUARE	730	INCL	365	445	405
GV36SQ	91 KG / 200 LBS. 91CM / 36.0" SQUARE	1025	INCL	365	445	405
GV30+30SQ	127 KG / 280 LBS. 76CM / 30.0" SQUARE DOUBLE-STACK	1455	INCL	365	445	405
GV36+36SQ	181 KG / 400 LBS. 91CM / 36.0" SQUARE DOUBLE-STACK	2050	INCL	365	445	405
GV36X3SQ	272 KG / 600 LBS. 91CM / 36.0" SQUARE TRIPLE-STACK	3075	INCL	365	445	405
GV36X4SQ	363 KG / 800 LBS. 91CM / 36.0" SQUARE QUAD-STACK	4100	INCL	365	445	405

ABOVE GROUND ANCHOR INSTALLATION PROCESS

 <p>BEAUTY COVER INCLUDED TO CONCEAL HARDWARE</p>					
ALL MAX PARASOLS ARE SHIPPED WITH STAINLESS STEEL SECURITY STEM AND BEAUTY COVER	ALUMA-CRETE ROUND ANCHOR	G-PLATE ANCHOR	LEVER LOCKS PARASOLS INTO STEM AFFIXED TO ANCHOR	CAM LOCK LEVER ALLOWS 360° ROTATION. CENTER POST AFFIXES TO SECURITY STEM USING LEVEL	G-PLATE ANCHORS WITH A COVER.

ABOVE GROUND SHADE ANCHORS OVERVIEW & PRICING

FULL ALUMA-CRETE CUBE ANCHOR

ALL MAX PARASOLS SHIP WITH STAINLESS STEEL SECURITY STEM & BEAUTY COVER. FOR USE WITH 60MM & 73MM MAST DIAMETERS.
 NOT COMPATIBLE WITH AMBIA LED LIGHT & HEATING.
 TOLERANCES +/- 4.5KG / 10 LBS

FULL ALUMA-CRETE CUBE ANCHOR			FINISH	
<p>L: 116cm W: 116cm H: 20cm</p>		LIST PRICE EUR	POWDER COAT OPTIONS: SEE BELOW. MARINE SILVER NOT AVAILABLE.	
AGSP	COMPLETE ASSEMBLY: FULL FRAME, PAVERS & COVER 317 KG / 700 LBS - 8 PAVERS		2415	INCL
AGSP	COMPLETE ASSEMBLY: FULL FRAME, PAVERS & COVER 437 KG / 963.5 LBS - 12 PAVERS	2760	INCL	

FULL CUBE CUSHION

UPHOLSTERED OPEN CELL FOAM. INDICATE ELECTRICAL OPTIONS

FULL CUBE CUSHION		FABRIC		FABRIC UPGRADE	
<p>L: 116cm W: 116cm H: 20cm</p>		LIST PRICE EUR	CXT & LXT SERIES. LEVEL B SEE PAGE 133 FOR DETAILS	ALL PXT SERIES. LEVEL C SEE PAGE 133 FOR DETAILS	ALL PXT SERIES. LEVEL E SEE PAGE 133 FOR DETAILS
AGSP-FCC	FULL CUBE CUSHION ONLY		2350		

FINISHES

Plantation Aluma-TEAK™

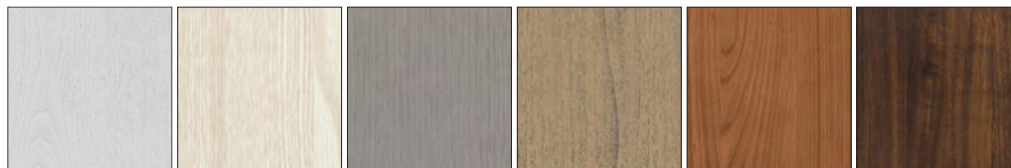

Aspen White Cypress Driftwood Weathered Natural Java

Powder Coat



Marine Silver Silver Sand Glacier White Sandbar Oyster Night Fog Espresso Graphite Black Sea

IN GROUND SHADE ANCHORS OVERVIEW & PRICING

IN GROUND SECURITY MOUNT ANCHOR

COMPATIBLE WITH ALL MAX ANCHOR STEMS.
ALL MAX PARASOLS SHIP WITH STAINLESS STEEL SECURITY STEM & BEAUTY COVER.

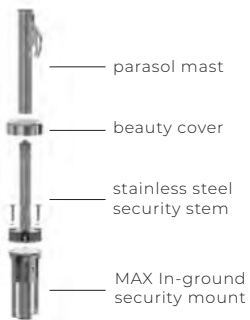
FOR USE IN NEW POUR CONCRETE		
 <p>15,2cm</p> <p>31,5 cm</p>	 <p>parasol mast</p> <p>beauty cover</p> <p>stainless steel security stem</p> <p>MAX In-ground security mount</p>	LIST PRICE EUR
IGSM	INSTALLATION PROCESS DEPICTED ABOVE	

STAINLESS STEEL SURFACE ANCHOR

COMPATIBLE WITH ALL MAX ANCHOR STEMS. INCLUDES 8 DROP-IN EXPANSION ANCHORS. THE SURFACE ANCHOR REQUIRES 4,000 PSI CONCRETE THAT IS AT LEAST 10CM / 4" DEEP FOR PROPER INSTALLATION. ALL MAX PARASOLS SHIP WITH STAINLESS STEEL SECURITY STEM & BEAUTY COVER.

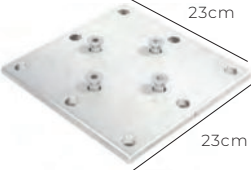
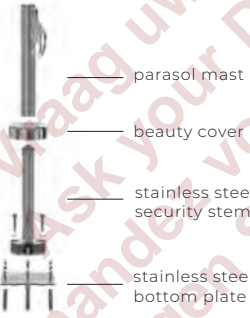
FOR USE ON EXISTING CONCRETE PAD		
 <p>23cm</p> <p>23cm</p>	 <p>parasol mast</p> <p>beauty cover</p> <p>stainless steel security stem</p> <p>stainless steel bottom plate</p>	LIST PRICE EUR
MAXPLATE	INSTALLATION PROCESS DEPICTED ABOVE	

STAINLESS STEEL FLUSH MOUNT MAX

INCLUDES 4 SEISMIC ANCHOR BOLTS. REQUIRES CORE DRILLING IN DRY CONCRETE ALUMINUM ADAPTER SHIPS WITH MAX PARASOLS. FOR USE WITH 60MM OR 73MM DIA. ALUMINUM ADAPTER. PARASOL SPECIFICS REQUIRED TO ENSURE THE CORRECT ADAPTER SIZE IS INCLUDED

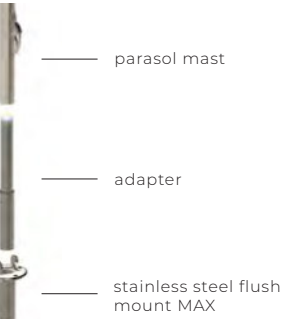
FOR DRY AND NEW POUR CONCRETE		
 <p>20cm</p> <p>25 cm</p>	 <p>parasol mast</p> <p>adapter</p> <p>stainless steel flush mount MAX</p>	LIST PRICE EUR
OMXSSFM	INSTALLATION PROCESS DEPICTED ABOVE	

STAINLESS STEEL FLUSH MOUNT MAX

FOR WOOD DECK WITH SIDE MOUNT BRACKET INSTALLATION (MAX PARASOLS SHIP WITH ALUMINUM ADAPTER). FOR USE WITH 60MM OR 73MM DIA. ALUMINUM ADAPTER INCLUDES BOLTS FOR SIDE MOUNT

FOR WOOD DECK		
		LIST PRICE EUR 1240
OMXSSFM(D)	INSTALLATION PROCESS DEPICTED ABOVE	

SHADE ANCHORS ACCESSORIES & PRICING

MAX EXTENSION & ALUMINUM COVER

FOR USE WITH ALL MAX ANCHOR STEMS. SPECIFY SIZE BETWEEN 5CM - 50CM / 2" - 20".

STANDARD FINISH IS SILVER SAND. INDICATE PARASOL SIZE & STYLE, SPECIFY SIZE BETWEEN 10CM - 40CM / 4" - 16".

STAINLESS STEEL EXTENSION	XPRESS	
	LIST PRICE EUR 750	XPRESS SHIPPING 950
BASE-EXT		

ALUMINUM EXTENSION COVER	FINISH	FINISH UPGRADE
	POWDER COAT OPTIONS: SEE PAGE 39 MARINE SILVER NOT AVAILABLE.	PLANTATION ALUMA-TEAK SEE PAGE 39
BASE-EXTCV	INCL	185

POOL APPLICATIONS

Recommended for new pool or poolside installation, not existing pools.

FOR USE ON 60MM / 2 3/8" MAST ONLY.
CAN ONLY BE USED WITH AUTO-LOC LIFT PULLEY OPTION
NOTE: EASYDRIVE CRANK LIFT SYSTEM CANNOT BE USED IN A POOL OR WATER APPLICATION

INCLUDES GROUNDING LUG..

STAINLESS STEEL MAX CENTER POST	LIST PRICE EUR
	1605
SSXCPMAST	

STAINLESS STEEL DOME COVER	LIST PRICE EUR
	515
80055	

STAINLESS STEEL MAX FLUSH MOUNT	LIST PRICE EUR
	1115
OMXSSFM(GL)	
GROUNDINGLUG	40

PRODUCT ANATOMY

OCEAN MASTER CANTILEVER

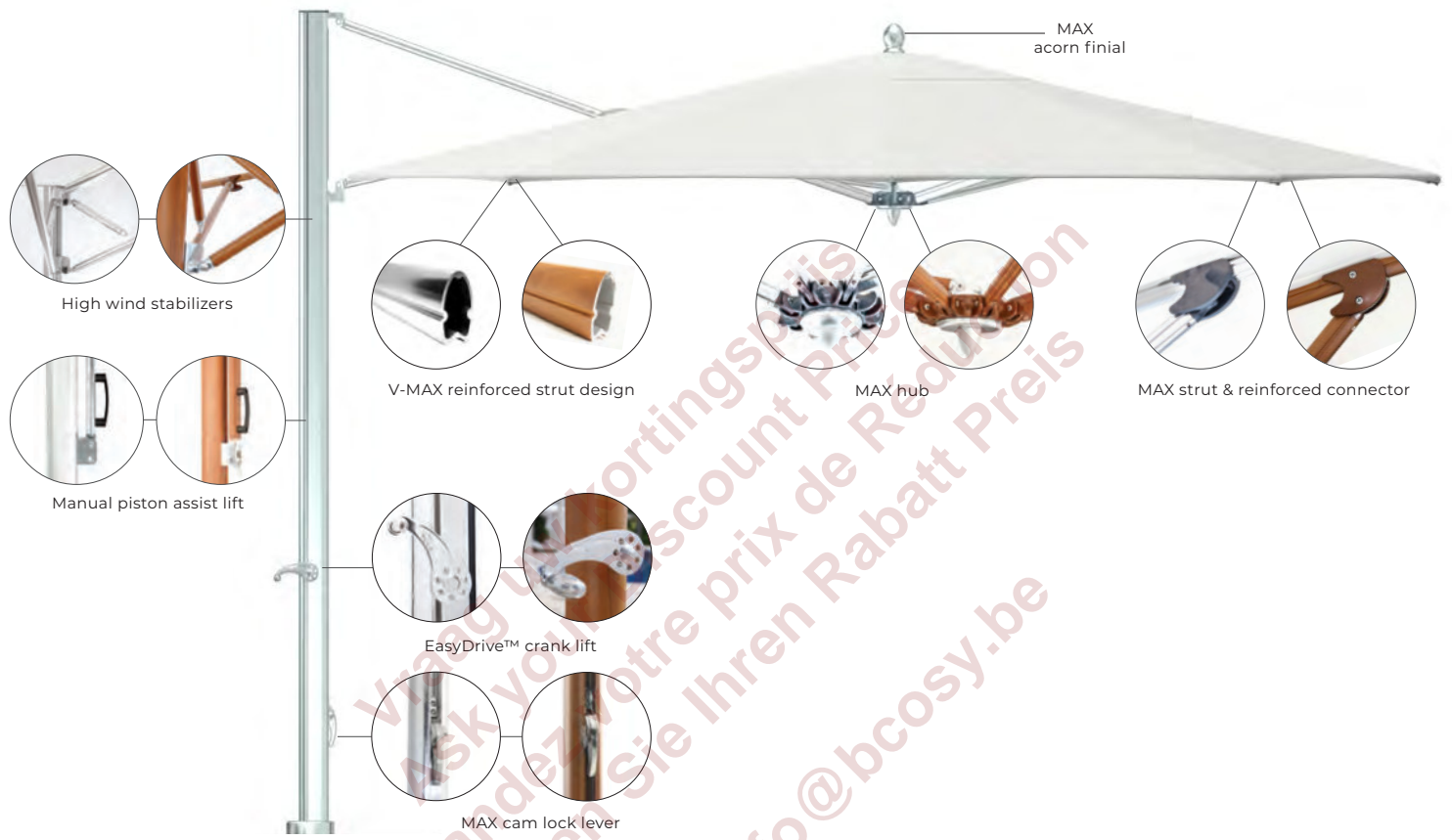

FLAG-SHIP



POLISHED TITANIUM

POWDER COAT



SILVER SAND



GLACIER WHITE



SANDBAR



OYSTER



NIGHT FOG



ESPRESSO



GRAPHITE



BLACK SEA

PLANTATION ALUMA-TEAK™



ASPEN WHITE



CYPRESS



DRIFTWOOD



WEATHERED



NATURAL







JAVA

PRODUCT OVERVIEW & PRICING

OCEAN MASTER MAX CLASSIC CANTILEVER

The Ocean Master MAX Classic Cantilever is simply art and engineering harmonizing in a symphony of shade. The polished and anodized marine grade canopy structure cantilevers from a sturdy, oval shaped mast inspired by sailing yachts. With the combined features of an ultra strong aluminum milled fulcrum and automatic telescoping mast, the canopy of this side post parasol easily closes over tables and chairs.

Standard features include: security stem, polished titanium hub and MAX acorn finial. Deduct €470 for Manual Piston Assisted lift.

OCEAN MASTER MAX CLASSIC CANTILEVER			STANDARD INCLUDED					FINISH UPGRADE		CANOPY ENHANCEMENT				COVER BAG			ANCHOR				
			FABRIC	VENT	PROFILE	LIFT	FINISH	655	1610	470	995	995	910	330	720	1170	WEIGHT				
 <p>LIST PRICE EUR</p>			ALL MXT SERIES, SEE PAGE 133 FOR DETAILS & OTHER OPTIONS.					SINGLE WIND VENT (MATCHING STANDARD, CONTRASTING OPTION)		MARKET CUT PROFILE				EASY DRIVE CRANK W/ TELESCOPING MAST			POLISHED TITANIUM				
			POWDER COAT OPTIONS SEE PAGE 45 FOR DETAILS					PLANTATION ALUMA-TEAK™ OPTIONS SEE PAGE 45 FOR DETAILS		CONTRASTING BINDING (CANOPY AND VENT)				15CM ACCENT BORDER ON CANOPY			VALANCE (STRAIGHT, SCALLOPED, CLASSIC OR MODERN ROMAN)	15CM CORD FRINGE	STANDARD POLYESTER DARK GREY PROTECTIVE COVER		
SQUARE			LEVEL C							PP. 142-143 FOR MORE ENHANCEMENTS											
CL8.0SQ	8.0' / 2.45M	8525	INCL	INCL	INCL	INCL	INCL	0	0	0	0	0	0	SC2	CC2	CC2H	127KG				
CL8.0SQ-TILT	8.0' / 2.45M INCL. TILT*	9360	INCL	INCL	INCL	INCL	INCL	0	0	0	0	0	0	SC2	CC2	CC2H	180KG				
CL8.0SQ-HWS	8.0' / 2.45M INCL. HWS**	9305	INCL	INCL	INCL	INCL	INCL	0	0	0	0	0	0	SC2	CC2	CC2H	180KG				
CL10.0SQ	10.0' / 3.0M	8660	INCL	INCL	INCL	INCL	INCL	0	0	0	0	0	0	SC2	CC2	CC2H	180KG				
CL10.0SQ-TILT	10.0' / 3.0M INCL. TILT*	9620	INCL	INCL	INCL	INCL	INCL	0	0	0	0	0	0	SC2	CC2	CC2H	180KG				
CL10.0SQ-HWS	10.0' / 3.0M INCL. HWS**	9440	INCL	INCL	INCL	INCL	INCL	0	0	0	0	0	0	SC2	CC2	CC2H	180KG				
CL12.0SQ-HWS	12.0' / 3.65M INCL. HWS**	10660	INCL	INCL	INCL	INCL	INCL	0	0	0	0	0	0	SC4	CC4	CC4H	180KG				
CL13.0SQ-HWS	13.0' / 4M INCL. HWS**	11180	INCL	INCL	INCL	INCL	INCL	0	0	0	0	0	0	SC4	CC4	CC4H	180KG				
OCTAGON			LEVEL C							PP. 142-143 FOR MORE ENHANCEMENTS											
CL9.0OCT	9.0' / 2.75M	8945	INCL	INCL	INCL	INCL	INCL	0	0	0	0	0	0	SC2	CC2	CC2H	127KG				
CL9.0OCT-TILT	9.0' / 2.75M INCL. TILT*	9780	INCL	INCL	INCL	INCL	INCL	0	0	0	0	0	0	SC2	CC2	CC2H	180KG				
CL9.0OCT-HWS	9.0' / 2.75M INCL. HWS**	9725	INCL	INCL	INCL	INCL	INCL	0	0	0	0	0	0	SC2	CC2	CC2H	180KG				
CL11.0OCT	11.0' / 3.4M	9490	INCL	INCL	INCL	INCL	INCL	0	0	0	0	0	0	SC2	CC2	CC2H	180KG				
CL11.0OCT-HWS	11.0' / 3.4M INCL. HWS**	10270	INCL	INCL	INCL	INCL	INCL	0	0	0	0	0	0	SC2	CC2	CC2H	180KG				
CL13.0OCT-HWS	13.0' / 4.0M INCL. HWS**	11285	INCL	INCL	INCL	INCL	INCL	0	0	0	0	0	0	SC2	CC2	CC2H	180KG				
RECTANGLE			LEVEL C							PP. 142-143 FOR MORE ENHANCEMENTS											
CL8X12RECT	8.0' X 12.0' / 2.45M X 3.65M	8945	INCL	INCL	INCL	INCL	INCL	0	0	0	0	0	0	SC2	CC2	CC2H	180KG				
CL8X12RECT-HWS	8.0' X 12.0' / 2.45M X 3.65M INCL. HWS**	9725	INCL	INCL	INCL	INCL	INCL	0	0	0	0	0	0	SC2	CC2	CC2H	180KG				
CL10X14RECT-HWS	10.0' X 14.0' / 3.0M X 4.25M INCL. HWS**	10815	INCL	INCL	INCL	INCL	INCL	0	0	0	0	0	0	SC4	CC4	CC4H	180KG				





* Tilt option to block the sun at any angle. No telescoping mast.

** HWS stands for High Wind Stabilizers.

PRODUCT OVERVIEW & PRICING

OCEAN MASTER MAX CLASSIC DUAL CANTILEVER

Tuuci's Ocean Master MAX Classic Dual Cantilever is art and engineering harmonizing in a symphony of shade. This exquisite double parasol provides a generously proportioned luxurious shade allowing for two unique outdoor living areas beneath one parasol unit—uninterrupted shade at its finest. **Standard features include:** security stem, polished titanium hub and MAX acorn finial.

OCEAN MASTER MAX CLASSIC DUAL CANTILEVER		LIST PRICE EUR	STANDARD INCLUDED					FINISH UPGRADE		CANOPY ENHANCEMENT				COVER BAG	ANCHOR
			FABRIC	VENT	PROFILE	LIFT	FINISH	1310	3225	895	1910	1910	1820	720	WEIGHT
			ALL MXT SERIES. SEE PAGE 133 FOR DETAILS & OTHER OPTIONS.					POLISHED TITANIUM		CONTRASTING BINDING (CANOPY AND VENT)				CUSTOM PROTECTIVE COVER TWO COVER BAGS NEEDED	MINIMUM RECOMMENDED WEIGHT
SQUARE			LEVEL C							PP. 142-143 FOR MORE ENHANCEMENTS					
CLD8.0SQ	8.0' X 16.0' / 2.45M X 4.9M	15860	INCL	INCL	INCL	INCL	INCL	o	o	o	o	o	o	CXD3	180KG
CLD8.0SQ-HWS	8.0' X 16.0' / 2.45M X 4.9M INCL. HWS**	17420	INCL	INCL	INCL	INCL	INCL	o	o	o	o	o	o	CXD3	180KG
CLD10.0SQ	10.0' X 20.0' / 3.0M X 6.0M	16145	INCL	INCL	INCL	INCL	INCL	o	o	o	o	o	o	CXD3	180KG
CLD10.0SQ-HWS	10.0' X 20.0' / 3.0M X 6.0M INCL. HWS**	17705	INCL	INCL	INCL	INCL	INCL	o	o	o	o	o	o	CXD3	180KG
CLD12.0SQ-HWS	12.0' X 24.0' / 3.65M X 7.4M INCL. HWS**	19240	INCL	INCL	INCL	INCL	INCL	o	o	o	o	o	o	CXD1	270KG
CLD13.0SQ-HWS	13.0' X 26.0' / 4.0 M X 7.9M INCL. HWS**	22100	INCL	INCL	INCL	INCL	INCL	o	o	o	o	o	o	CXD1	270KG
OCTAGON			LEVEL C							PP. 142-143 FOR MORE ENHANCEMENTS					
CLD9.0OCT	9.0' X 18.0' / 2.75M X 5.4M	15495	INCL	INCL	INCL	INCL	INCL	o	o	o	o	o	o	CXD2	180KG
CLD9.0OCT-HWS	9.0' X 18.0' / 2.75M X 5.4M INCL. HWS**	17055	INCL	INCL	INCL	INCL	INCL	o	o	o	o	o	o	CXD2	180KG
CLD11.0OCT	11.0' X 22.0' / 3.4M X 6.8M	17055	INCL	INCL	INCL	INCL	INCL	o	o	o	o	o	o	CXD2	180KG
CLD11.0OCT-HWS	11.0' X 22.0' / 3.4M X 6.8M INCL. HWS**	18615	INCL	INCL	INCL	INCL	INCL	o	o	o	o	o	o	CXD2	180KG
CLD13.0OCT-HWS	13.0' X 26.0' / 4.0M X 8.0M INCL. HWS**	19500	INCL	INCL	INCL	INCL	INCL	o	o	o	o	o	o	CXD3	270KG
RECTANGLE			LEVEL C							PP. 142-143 FOR MORE ENHANCEMENTS					
CLD16X12RECT	16.0' X 12.0' / 4.9M X 3.65M	17160	INCL	INCL	INCL	INCL	INCL	o	o	o	o	o	o	CXD3	180KG
CLD16X12RECT-HWS	16.0' X 12.0' / 4.9M X 3.65M INCL. HWS**	18720	INCL	INCL	INCL	INCL	INCL	o	o	o	o	o	o	CXD3	180KG
CLD20X14RECT-HWS	20.0' X 14.0' / 6.0M X 4.25M INCL. HWS**	20695	INCL	INCL	INCL	INCL	INCL	o	o	o	o	o	o	CXD1	270KG

** HWS stands for High Wind Stabilizers.

SHADE SCULPTURE — STINGRAY

The stingray requires in ground security mount system. This is a non-collapsible shade sculpture. Open weave fabric recommended for windy locations. **Standard features include:** non-vented one piece canopy.

STINGRAY		LIST PRICE EUR	STANDARD INCLUDED		ANCHOR
			FABRIC	LEVEL C	WEIGHT
			ALL MXT SERIES. SEE PAGE 133 FOR DETAILS & OTHER OPTIONS.		MINIMUM RECOMMENDED WEIGHT. IN-GROUND ONLY
M1SR7X10	7.0' X 10.0' / 2.15M X 3M	12540	INCL		270KG
M1SR9X13	9.0' X 13.0' / 2.75M X 4M	18250	INCL		270KG

PRODUCT UPGRADES

AMBIA™ LED LIGHT, HEATING (220V) AND AUTOMATION

The Ambia™ LED Light is an ambient light that illuminates upward into the canopy. Please note that lighter canopy fabric colors reflect the light more efficiently than darker colors. Battery power pack for Ambia LED Light only.

Not compatible with the AGSP or AGSP2 Aluma-Crete Cube Above Ground Anchors.

MAX SINGLE CANTILEVER	FEATURE	AMBIA LED LIGHT		AMBIA LED LIGHT AND 2 HEATERS (220V REQUIRED)	AMBIA LED LIGHT AND AUTOMATION	AMBIA LED LIGHT, 2 HEATERS AND AUTOMATION (220V REQUIRED)
		STANDARD POWER (220V)	BATTERY POWER			
	PRICE	1105	1725	5445	4525	7060
MAX DUAL CANTILEVER	FEATURE	AMBIA LED LIGHT		2 AMBIA LED LIGHTS AND 4 HEATERS (220V REQUIRED)	2 AMBIA LED LIGHTS AND AUTOMATION	2 AMBIA LED LIGHTS, 4 HEATERS AND AUTOMATION (220V REQUIRED)
		STANDARD POWER (220V)	BATTERY POWER			
	PRICE	1690	2635	9910	5080	11455



Touch control On/off & dimming

Available lift systems:
Auto-lift assist piston
EasyDrive crank with telescoping mast tilt



AMBIA LED LIGHT

Independent up dimming

Lift system:
EasyDrive crank w/ telescoping mast
Indicate white or black heaters

Power on/off

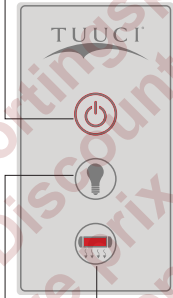

Heater

Ambia LED light On/off only No dimming

Lift system:
Touch pad
Indicate white or black heaters

Power on/off

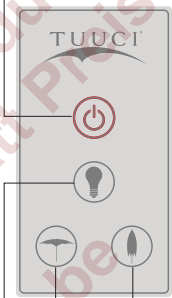

Automation

Ambia LED light On/off only No dimming

Lift system:
Touch pad
Indicate white or black heaters

Power on/off

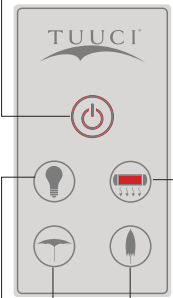

Automation

Heater

Ambia LED light On/off only No dimming

ORDERS WITH VALANCE:
BACK VALANCE OF CANOPY WILL BE OMITTED

BATTERY OPTIONS <i>Indicate US, European or Asia.</i>	ADDITIONAL BATTERY	ADDITIONAL SINGLE BAY CHARGER <i>(charges 1 battery)</i>	ADDITIONAL QUAD BAY CHARGER <i>(charges 4 batteries)</i>
		275 NET	250 NET

AMBIA LED LIGHTS



BATTERY



HEATING



AUTOMATION

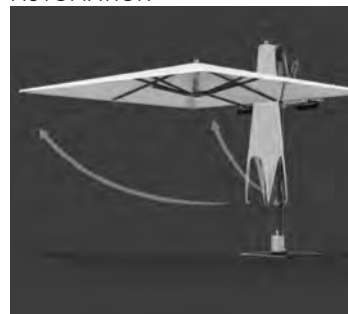

Select lighting and heating options when placing your order. These options cannot be retrofitted to existing parasols. Lights and heaters will be pre-installed at the factory and shipped with the parasol. External AC (110V or 240V) comes out of the bottom of the mast with a set 10' cord and plug. The customer is responsible for the onsite connection, and can either remove the plug and hardwire or adapt the plug to accommodate the various configurations by country. Lighting meets the applicable UL Codes in the US and CE codes in Europe. Approvals are pending. This electrical system is not UL rated.

The Ambia™ LED Light is bright enough for commercial settings. Low voltage -- direct current 12 volts. The temperature range is 2700K to 2900K.

Features of the heating device: Safe, maintenance free, odorless infrared heating element rated for outdoor/indoor areas. Adjustable bracket for easy orientation and auto switch to turn device off when parasol is closed. Scratch resistant, sleek aluminum fixture, with hard-wearing finish available in black or white. UL Certified and operates for as little as 0.20 per hour.

Heating requires 220V and may require an electrician to modify standard outlet to accommodate.

ABOVE GROUND SHADE ANCHORS OVERVIEW & PRICING

G-MAX PLATE ANCHORS

GALVANIZED STEEL WITH STAINLESS STEEL SECURITY STEM.
ALL MAX PARASOLS SHIP WITH STAINLESS STEEL SECURITY STEM & BEAUTY COVER. TOLERANCES +/- 4.5 KG / 10 LBS

G-PLATE ANCHORS		LIST PRICE EUR	FINISH	ANCHOR COVERS (TOP G-PLATE ONLY)		TUFF WHEELS
				POWDER COAT OPTIONS: SEE PAGE 51 MARINE SILVER NOT AVAILABLE.	PLANTATION ALUMA-TEAK SEE PAGE 51	
GV36SQ	91 KG / 200 LBS. 91CM / 36.0" SQUARE	1025	INCL	365	445	405
GV30+30SQ	127 KG / 280 LBS. 76CM / 30.0" SQUARE DOUBLE-STACK	1455	INCL	365	445	405
GV36+36SQ	181 KG / 400 LBS. 91CM / 36.0" SQUARE DOUBLE-STACK	2050	INCL	365	445	405
GV36X3SQ	272 KG / 600 LBS. 91CM / 36.0" SQUARE TRIPLE-STACK	3075	INCL	365	445	405
GV36X4SQ	363 KG / 800 LBS. 91CM / 36.0" SQUARE QUAD-STACK	4100	INCL	365	445	405

** Tuuci advises to use G-MAX Plate anchor 272kg square for 400cm square MAX cantilevers in combination with wheels.

Vraag uw kortingsprijs
Ask your Discount Price
Demandez votre prix de Réduction
Fragen Sie Ihren Rabatt Preis
info@bcosy.be

TUFF WHEELS



ANCHOR COVER -
POWDER COAT

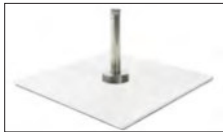

ANCHOR COVER -
PLANTATION ALUMA-TEAK

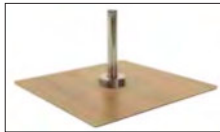

ABOVE GROUND ANCHOR INSTALLATION PROCESS

 <p>BEAUTY COVER INCLUDED TO CONCEAL HARDWARE</p>	 <p>G-PLATE ANCHOR</p>	 <p>LEVER LOCKS PARASOLS INTO STEM AFFIXED TO ANCHOR</p>	 <p>CAM LOCK LEVER ALLOWS 360° ROTATION. CENTER POST AFFIXES TO SECURITY STEM USING LEVEL</p>	 <p>G-PLATE ANCHORS WITH A COVER.</p>
<p>ALL MAX PARASOLS ARE SHIPPED WITH STAINLESS STEEL SECURITY STEM AND BEAUTY COVER</p>				

ABOVE GROUND SHADE ANCHORS OVERVIEW & PRICING

HALF ALUMA-CRETE CUBE ANCHOR

ALL MAX PARASOLS SHIP WITH STAINLESS STEEL SECURITY STEM & BEAUTY COVER.
 NOT COMPATIBLE WITH AMBIA LED LIGHT & HEATING. NOT FOR USE WITH DUAL CANTILEVERS.
 TOLERANCES +/- 4.5KG / 10 LBS

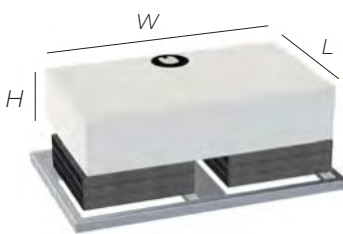
HALF ALUMA-CRETE CUBE ANCHOR		LIST PRICE EUR	FINISH	FINISH UPGRADE
 <p>L: 68cm W: 116cm H: 20cm</p>			POWDER COAT OPTIONS: SEE BELOW. MARINE SILVER NOT AVAILABLE.	PLANTATION ALUMA-TEAK SEE BELOW
AGSP2	COMPLETE ASSEMBLY: HALF FRAME, PAVERS & COVER 236 KG / 520.5 LBS - 6 PAVERS	1985	INCL	330
AGSP2	COMPLETE ASSEMBLY: HALF FRAME, PAVERS & COVER 296 KG / 652.5 LBS - 8 PAVERS	2155	INCL	330
AGSP2	COMPLETE ASSEMBLY: HALF FRAME, PAVERS & COVER 351 KG / 773.5 LBS - 8 PAVERS + 2 G-PLATES	2685	INCL	330

HALF CUBE CUSHION

UPHOLSTERED OPEN CELL FOAM. INDICATE ELECTRICAL OPTIONS

HALF CUBE CUSHION		LIST PRICE EUR	FABRIC	FABRIC UPGRADE
 <p>L: 68cm W: 116cm H: 20cm</p>			CXT & LXT SERIES. LEVEL B. SEE PAGE 133 FOR DETAILS	ALL PXT SERIES. LEVEL C. SEE PAGE 133 FOR DETAILS
AGSP2-HCC	HALF CUBE CUSHION ONLY	1350	INCL	20%

FINISHES

Plantation Aluma-TEAK™

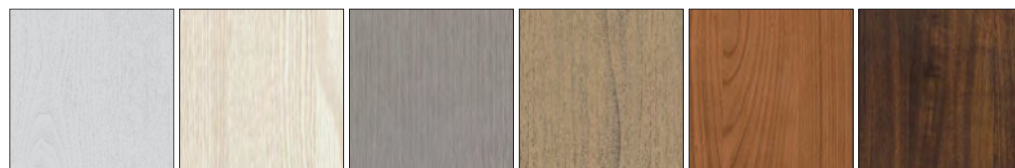

Aspen White Cypress Driftwood Weathered Natural Java

Powder Coat



Marine Silver Silver Sand Glacier White Sandbar Oyster Night Fog Espresso Graphite Black Sea

IN GROUND SHADE ANCHORS OVERVIEW & PRICING

IN GROUND SECURITY MOUNT ANCHOR

COMPATIBLE WITH ALL MAX ANCHOR STEMS.
ALL MAX PARASOLS SHIP WITH STAINLESS STEEL SECURITY STEM & BEAUTY COVER.

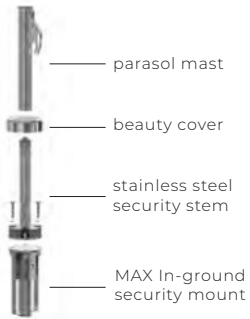
FOR USE IN NEW POUR CONCRETE		
 <p>15,2cm 31,5 cm</p>	 <p>parasol mast beauty cover stainless steel security stem MAX In-ground security mount</p>	LIST PRICE EUR
IGSM	INSTALLATION PROCESS DEPICTED ABOVE	

STAINLESS STEEL SURFACE ANCHOR

COMPATIBLE WITH ALL MAX ANCHOR STEMS. INCLUDES 8 DROP-IN EXPANSION ANCHORS.
THE SURFACE ANCHOR REQUIRES 4,000 PSI CONCRETE THAT IS AT LEAST 10CM / 4" DEEP FOR PROPER INSTALLATION. ALL MAX PARASOLS SHIP WITH STAINLESS STEEL SECURITY STEM & BEAUTY COVER.

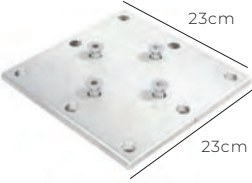
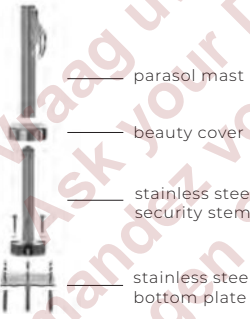
FOR USE ON EXISTING CONCRETE PAD		
 <p>23cm 23cm</p>	 <p>parasol mast beauty cover stainless steel security stem stainless steel bottom plate</p>	LIST PRICE EUR
MAXPLATE	INSTALLATION PROCESS DEPICTED ABOVE	

SHADE ANCHORS ACCESSORIES & PRICING

MAX EXTENSION & ALUMINUM COVER

FOR USE WITH ALL MAX CANTILEVER ANCHOR STEMS.
ORDER IN ANY INCREMENT FROM 10CM - 40CM / 4" - 16".

STANDARD FINISH IS SILVER SAND. INDICATE PARASOL SIZE & STYLE.

STAINLESS STEEL EXTENSION	XPRESS	
	LIST PRICE EUR	XPRESS SHIPPING
BASE-EXT	750	950

ALUMINUM EXTENSION COVER	FINISH	FINISH UPGRADE
	POWDER COAT OPTIONS SEE PAGE 51 MARINE SILVER NOT AVAILABLE.	PLANTATION ALUMA-TEAK SEE PAGE 51
BASE-EXTCV	700	185

** 25cm / 10" is the max. height for Ocean Master MAX Classic Cantilever sizes 365cm / 12' SQ, 400cm / 13' SQ, 400cm / 13' OCT and 305x425 / 10'x14' RECT.

PRODUCT ANATOMY



OCEAN MASTER CENTER POST



PRODUCT OVERVIEW & PRICING



OCEAN MASTER M1 RAZOR

The Razor's striking asymmetrical construction features a razor-like, self-tilting canopy profile. It's now possible to enjoy all-day shade under your Tuuci parasol no matter what. **Standard features include:** non-vented fishtail canopy, polished titanium hub & triton finial. Additional mast length €125, specify 10, 20, 30cm.

OCEAN MASTER M1 RAZOR				STANDARD INCLUDED				FINISH UPGRADE		LIFT UPGRADE	MAST UPGRADE	CANOPY ENHANCEMENT			COVER BAG		ANCHOR
				FABRIC	PROFILE	LIFT	FINISH	190	445	190	95	115	250	545	155	510	WEIGHT
	MAST DIAMETER IN MM	LIST PRICE EUR		ALL MXT SERIES. SEE PAGE 133 FOR DETAILS & OTHER OPTIONS.	FISHTAIL PROFILE. INCLUDES CANOPY BINDING (MATCHING STANDARD, CONTRASTING OPTION)	AUTO-LOC MARINE PULLEY LIFT	POLISHED TITANIUM	POWDER COAT OPTIONS SEE PAGE 55 FOR DETAILS	PLANTATION ALUMA-TEAK™ OPTIONS SEE PAGE 55 FOR DETAILS	EASYDRIVE CRANK LIFT	M1 PLUS - 51MM / 2.0" DIAMETER MAST (SELECT 51MM / 2.0" STAINLESS STEEL SECURITY SLEEVE. UPCHARGE OF €70)	CONTRASTING BINDING ON CANOPY	15CM ACCENT BORDER ON CANOPY	15CM CORD FRINGE	STANDARD POLYESTER DARK GREY PROTECTIVE COVER	CUSTOM PROTECTIVE COVER	MINIMUM RECOMMENDED WEIGHT
OCTAGON			LEVEL C								PP. 142-143 FOR MORE ENHANCEMENTS						
OMR11.0OCT	11.0' / 3.4M	38.1	2775	INCL	INCL	INCL	INCL	o	o	o	o	o	o	o	SS4	CS4	82G



OCEAN MASTER M1 CRESCENT

Inspired by centuries past and present, the sweeping curves of the Crescent parasol are the finishing touch every outdoor room deserves. Brilliantly polished rib end caps adorn the canopy edges to create a simple yet strikingly beautiful canopy. **Standard features include:** non-vented fishtail canopy, polished titanium hub & venice finial. Additional mast length €125, specify 10, 20, 30cm. For larger sizes see the MAX collection.

OCEAN MASTER M1 CRESCENT				STANDARD INCLUDED				FINISH UPGRADE		LIFT UPGRADE	MAST UPGRADE	CANOPY ENHANCEMENT			COVER BAG		ANCHOR
				FABRIC	PROFILE	LIFT	FINISH	190	190	95	115	250	545	155	510	WEIGHT	
	MAST DIAMETER IN MM	LIST PRICE EUR		ALL MXT SERIES. SEE PAGE 133 FOR DETAILS & OTHER OPTIONS.	FISHTAIL PROFILE. INCLUDES CANOPY BINDING (MATCHING STANDARD, CONTRASTING OPTION)	AUTO-LOC MARINE PULLEY LIFT	POLISHED TITANIUM	POWDER COAT OPTIONS SEE PAGE 55 FOR DETAILS	EASYDRIVE CRANK LIFT	M1 PLUS - 51MM / 2.0" DIAMETER MAST (SELECT 51MM / 2.0" STAINLESS STEEL SECURITY SLEEVE. UPCHARGE OF €70)	CONTRASTING BINDING ON CANOPY	15CM ACCENT BORDER ON CANOPY	15CM CORD FRINGE	STANDARD POLYESTER DARK GREY PROTECTIVE COVER	CUSTOM PROTECTIVE COVER	MINIMUM RECOMMENDED WEIGHT	
HEXAGON			LEVEL C								PP. 142-143 FOR MORE ENHANCEMENTS						
OMC8.0HEX	8.0' / 2.4M	38.1	2420	INCL	INCL	INCL	INCL	o	—	o	o	o	o	SS3	CS3	48KG	
OMC10.0HEX	10.0' / 3.0M	38.1	2550	INCL	INCL	INCL	INCL	o	o	o	o	o	o	SS3	CS3	48KG	
OMC12.0HEX	12.0' / 3.7M	38.1	2755	INCL	INCL	INCL	INCL	o	o	o	o	o	o	SS4	CS4	64KG	

NEW OCEAN MASTER M1 POLYNESIAN

Introducing the Ocean Master M1 Polynesian parasol, the latest addition to the Ocean Master M1 collection, where innovation meets cultural inspiration. This unique umbrella boasts a fresh teepee-shaped design that sets it apart from the ordinary. **Standard features include:** non-vented market cut canopy, polished titanium hub & triton finial. Additional mast length €125, specify 10, 20, 30cm.

OCEAN MASTER M1 POLYNESIAN				STANDARD INCLUDED				FINISH UPGRADE		CANOPY ENHANCEMENT		COVER BAG	ANCHOR
				FABRIC	PROFILE	LIFT	FINISH	190	445	115	250	510	WEIGHT
	MAST DIAMETER IN MM	LIST PRICE EUR		ALL MXT SERIES. SEE PAGE 133 FOR DETAILS & OTHER OPTIONS.	MARKET CUT PROFILE. INCLUDES CANOPY BINDING (MATCHING STANDARD, CONTRASTING OPTION)	DOUBLE PULLEY WITH PIN	POLISHED TITANIUM	POWDER COAT OPTIONS SEE PAGE 55 FOR DETAILS	PLANTATION ALUMA-TEAK™ SEE PAGE 55 FOR DETAILS	CONTRASTING POCKETS	15CM ACCENT BORDER ON CANOPY	CUSTOM PROTECTIVE COVER	MINIMUM RECOMMENDED WEIGHT
HEXAGON			LEVEL C								PP. 142-143 FOR MORE ENHANCEMENTS		
OMP8.5HEX	8.5' / 2.6M	38.1	2080	INCL	INCL	INCL	INCL	o	o	o	o	CS3	48KG

ABOVE GROUND SHADE ANCHORS OVERVIEW & PRICING

ALUMA-CRETE ROUND

ALUMINIUM, CONCRETE FILLED SHELL, FOUR HOLE VERSION WITH STAINLESS STEEL SECURITY SLEEVE.
SIZES REFER TO THE DIAMETER OF THE PARASOL MAST. EXAMPLE: FOR A 38.1MM / 1.5" MAST, SELECT A 38.1MM / 1.5" SECURITY SLEEVE.
TOLERANCES +/- 4.5 KG / 10 LBS

ALUMA-CRETE ROUND - STANDARD			FINISH	SECURITY SLEEVE	FINISH UPGRADE	SECURITY SLEEVE UPGRADE				SECURITY SLEEVE FINISH UPGRADE						
	STAINLESS STEEL SECURITY SLEEVE	LIST PRICE EUR	MARINE SILVER (STANDARD) POWDER COAT OPTIONS: SEE BELOW	38.1MM / 1.5" SECURITY SLEEVE	PLANTATION ALUMA-TEAK OPTIONS: SEE BELOW	44MM / 1.75" SECURITY SLEEVE	51MM / 2.0" SECURITY SLEEVE	57MM / 2.25" SECURITY SLEEVE	44MM / 1.75" SECURITY SLEEVE WITH EXTENSION (FOR 38.1MM / 1.5" MAST)	38.1MM / 1.5" AUTO-CAM LOCK SECURITY SLEEVE	POWDER COAT OPTIONS ONLY. SEE BELOW					
ACFW95	43 KG / 95 LBS. 61CM / 24.0" DIAMETER					505	INCL	INCL	145	40		70	—	90	115	45
ACFW150	68 KG / 150 LBS. 71CM / 28.0" DIAMETER					570	INCL	INCL	145	40		70	105	90	115	45

ALUMA-CRETE ROUND - WITH LIFT HANDLES			FINISH	SECURITY SLEEVE	FINISH UPGRADE	SECURITY SLEEVE UPGRADE				SECURITY SLEEVE FINISH UPGRADE						
	STAINLESS STEEL SECURITY SLEEVE	LIST PRICE EUR	MARINE SILVER (STANDARD) POWDER COAT OPTIONS: SEE BELOW	38.1MM / 1.5" SECURITY SLEEVE	PLANTATION ALUMA-TEAK OPTIONS: SEE BELOW	44MM / 1.75" SECURITY SLEEVE	51MM / 2.0" SECURITY SLEEVE	57MM / 2.25" SECURITY SLEEVE	44MM / 1.75" SECURITY SLEEVE WITH EXTENSION (FOR 38.1MM / 1.5" MAST)	38.1MM / 1.5" AUTO-CAM LOCK SECURITY SLEEVE	POWDER COAT OPTIONS ONLY. SEE BELOW					
ACF200	91 KG / 200 LBS. 76CM / 30.0" DIAMETER					820	INCL	INCL	230	40		70	105	90	115	45
ACF250	109 KG / 250 LBS. 84CM / 33.0" DIAMETER					930	INCL	INCL	230	40		70	105	90	115	45



FINISHES

Plantation Aluma-TEAK™

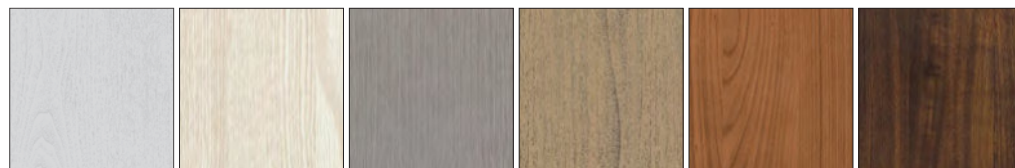

Aspen White Cypress Driftwood Weathered Natural Java

Powder Coat





Marine Silver Silver Sand Glacier White Sandbar Oyster Night Fog Espresso Graphite Black Sea

ABOVE GROUND SHADE ANCHORS OVERVIEW & PRICING

G-PLATE ANCHORS

GALVANIZED STEEL WITH STAINLESS STEEL SECURITY SLEEVE. SIZES REFER TO THE DIAMETER OF THE PARASOL MAST. EXAMPLE: FOR A 38.1MM / 1.5" MAST, SELECT A 38.1MM / 1.5" SECURITY SLEEVE. G-PLATES AND COVERS HAVE FOUR HOLE PATTERN.
TOLERANCES +/- 4.5 KG / 10 LBS

G-PLATE ROUND		LIST PRICE EUR	FINISH	SECURITY SLEEVE	ANCHOR COVERS (FOR TOP G-PLATE ONLY)		SECURITY SLEEVE UPGRADE					SECURITY SLEEVE FINISH UPGRADE	WHEEL TRAY
			GALVANIZED STEEL	38.1MM / 1.5" SECURITY SLEEVE	POWDER COAT OPTIONS: SEE PAGE 60 MARINE SILVER NOT AVAILABLE	PLANTATION ALUMA-TEAK OPTIONS: SEE PAGE 60	44MM / 1.75" SECURITY SLEEVE	51MM / 2.0" SECURITY SLEEVE	57MM / 2.25" SECURITY SLEEVE	44MM / 1.75" SECURITY SLEEVE WITH EXTENSION (FOR 38.1MM / 1.5" MAST)	38.1MM / 1.5" AUTO-CAM LOCK SECURITY SLEEVE	POWDER COAT OPTIONS ONLY: SEE PAGE 60 MARINE SILVER NOT AVAILABLE	STAINLESS STEEL WHEEL TRAY (FOR USE WITH ROUND G-PLATES)
GV24RND	34 KG / 75 LBS. 61CM / 24.0" DIAMETER	595	INCL	INCL	240	285	40	70	—	90	115	45	295
GV30RND	48 KG / 105 LBS. 76CM / 30.0" DIAMETER	765	INCL	INCL	240	285	40	70	105	90	115	45	295

G-PLATE ROUND - DOUBLE STACK		LIST PRICE EUR	FINISH	SECURITY SLEEVE	ANCHOR COVERS (FOR TOP G-PLATE ONLY)		SECURITY SLEEVE UPGRADE					SECURITY SLEEVE FINISH UPGRADE	WHEEL TRAY
			GALVANIZED STEEL	38.1MM / 1.5" SECURITY SLEEVE	POWDER COAT OPTIONS: SEE PAGE 60 MARINE SILVER NOT AVAILABLE	PLANTATION ALUMA-TEAK OPTIONS: SEE PAGE 60	44MM / 1.75" SECURITY SLEEVE	51MM / 2.0" SECURITY SLEEVE	57MM / 2.25" SECURITY SLEEVE	44MM / 1.75" SECURITY SLEEVE WITH EXTENSION (FOR 38.1MM / 1.5" MAST)	38.1MM / 1.5" AUTO-CAM LOCK SECURITY SLEEVE	POWDER COAT OPTIONS ONLY: SEE PAGE 60 MARINE SILVER NOT AVAILABLE	STAINLESS STEEL WHEEL TRAY (FOR USE WITH ROUND G-PLATES)
CV18+30R	66 KG / 145 LBS. 76CM / 30.0" DIAMETER	960	INCL	INCL	—	—	40	70	—	90	115	45	295
GV24+30R	82 KG / 180 LBS. 76CM / 30.0" DIAMETER	1130	INCL	INCL	—	—	40	70	105	90	115	45	295
GV30+30R	95 KG / 210 LBS. 76CM / 30.0" DIAMETER	1300	INCL	INCL	240	285	40	70	105	90	115	45	295

G-PLATE SQUARE		LIST PRICE EUR	FINISH	SECURITY SLEEVE	ANCHOR COVERS (FOR TOP G-PLATE ONLY)		SECURITY SLEEVE UPGRADE					SECURITY SLEEVE FINISH UPGRADE	TUFF WHEEL
			GALVANIZED STEEL	38.1MM / 1.5" SECURITY SLEEVE	POWDER COAT OPTIONS: SEE PAGE 60 MARINE SILVER NOT AVAILABLE	PLANTATION ALUMA-TEAK OPTIONS: SEE PAGE 60	44MM / 1.75" SECURITY SLEEVE	51MM / 2.0" SECURITY SLEEVE	57MM / 2.25" SECURITY SLEEVE	44MM / 1.75" SECURITY SLEEVE WITH EXTENSION (FOR 38.1MM / 1.5" MAST)	38.1MM / 1.5" AUTO-CAM LOCK SECURITY SLEEVE	POWDER COAT OPTIONS ONLY: SEE PAGE 60 MARINE SILVER NOT AVAILABLE	1 SET OF 4 WHEELS
GV24SQ	41 KG / 90 LBS. 61CM / 24.0" SQUARE	685	INCL	INCL	240	285	40	70	105	90	115	45	—
GV30SQ	64 KG / 135 LBS. 76CM / 30.0" SQUARE	955	INCL	INCL	365	445	40	70	105	90	115	45	405
GV24+24SQ	82 KG / 180 LBS. 61CM / 24.0" SQUARE	1145	INCL	INCL	240	285	40	70	105	90	115	45	—
GV36SQ	90 KG / 200 LBS. 90CM / 36.0" SQUARE	1255	INCL	INCL	365	445	40	70	105	90	115	45	405

IN GROUND SHADE ANCHORS OVERVIEW & PRICING

STAINLESS STEEL FLUSH MOUNT WITH CONCRETE CYLINDER

FOR SOFT SURFACES AND PAVERS. INCLUDES 61CM / 24" ALUMINUM EXTENSION SLEEVE FOR USE WITH A 38.1MM / 1.5" MAST. CONCRETE CYLINDER WEIGHS 50 KG / 110 LBS. TOLERANCES +/- 4.5 KG / 10 LBS

FOR USE IN NEW POUR CONCRETE, SOIL OR SAND		
		LIST PRICE EUR
SSFMC	INSTALLATION PROCESS DEPICTED ABOVE	

STAINLESS STEEL FLUSH MOUNT

FOR CONCRETE INSTALLATIONS: INCLUDES 3 DROP-IN ANCHOR BOLTS. 44.5MM / 1.75" DIAMETER STAINLESS STEEL FLUSH MOUNT. INCLUDES 61CM / 24" ALUMINUM EXTENSION SLEEVE FOR USE WITH A 38.1MM / 1.5" MAST.

FOR USE ON EXISTING CONCRETE PAD		
		LIST PRICE EUR
FLUSHMT	INSTALLATION PROCESS DEPICTED ABOVE	

SHADE ANCHORS ACCESSORIES & PRICING

STAINLESS STEEL SECURITY SLEEVE - DECK MOUNTS

THE STANDARD IS THE 38.1MM / 1.5" SECURITY SLEEVE. UPGRADING TO A LARGER SIZE HAS AN UPCHARGE. FOR CONCRETE INSTALLATIONS: INCL. 4 DROP-IN ANCHOR BOLTS

STAINLESS STEEL SECURITY SLEEVE - DECK MOUNTS				
			LIST PRICE EUR	
DECKMNT	38.1MM / 1.5" SECURITY SLEEVE			230
DECKMNT	44MM / 1.75" SECURITY SLEEVE			+40
DECKMNT	51MM / 2.0" SECURITY SLEEVE			+70
DECKMNT	57MM / 2.25" SECURITY SLEEVE			+105
DECKMNT	38.1MM / 1.5" AUTO-CAM LOCK SECURITY SLEEVE			+115

SHADE ANCHORS ACCESSORIES & PRICING

ACCESSORIES

FOR USE WITH 38.1MM / 1.5" MASTS. INCLUDES A STAINLESS STEEL HITCH PIN.

ALUMINUM SAND ANCHOR	
	
SANDANCHOR	LIST PRICE EUR 150

FOR USE WITH AUTO-LOC MARINE PULLEY LIFT SYSTEM.

SECOND ROPE HOOK	
	
ROPEHOOK	LIST PRICE EUR 85

6.35MM / 1/4" HOLE NEEDED IN MAST TO UTILIZE EXTENSION SLEEVE. 6.35MM / 1/4" DRILL BIT REQUIRED.

ADJUSTABLE EXTENSION SLEEVE WITH HITCH PIN		
		
EXTPOLE	ALUMINUM EXTENSION SLEEVE 24" LONG X 1.75" DIA. REQUIRES 1.75" SECURITY SLEEVE OR 1.75" STAINLESS STEEL FLUSHMOUNT	LIST PRICE EUR 100
SSEXTPOLE	STAINLESS STEEL EXTENSION SLEEVE 24" LONG X 1.75" DIA. REQUIRES 1.75" SECURITY SLEEVE OR BASE FOR HIGHLY CORROSIVE INSTALLATIONS INCLUDING POOLS	LIST PRICE EUR 340

POOL APPLICATIONS

Recommended for new pool or poolside installation, not existing pools.

FOR USE ON 38.1MM / 1.5" MAST ONLY. NOTE: EASYDRIVE CRANK LIFT SYSTEM CANNOT BE USED IN A POOL OR WATER APPLICATION

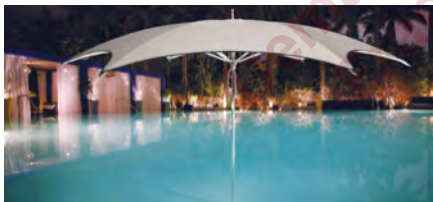
STAINLESS STEEL M1 CENTER POST		
		
SSCPMAST	MANUAL OR AUTO-LOC MARINE PULLEY LIFT	LIST PRICE EUR 680
SSCPMAST	AUTO-SCOPE MAST WITH AUTO-LOC MARINE PULLEY LIFT	LIST PRICE EUR 680

FOR USE ON 38.1MM / 1.5" MAST ONLY. INCLUDES 61CM / 24" STAINLESS STEEL EXTENSION. NOTE: EASYDRIVE CRANK LIFT SYSTEM CANNOT BE USED IN A POOL OR WATER APPLICATION

STAINLESS STEEL FLUSH MOUNT WITH STAINLESS STEEL EXTENSION		
 <p>15,2cm Hitch Pin</p>	 <p>Stainless Steel Containment Cup</p>	LIST PRICE EUR
FLUSHMTSS	STAINLESS STEEL FLUSH MOUNT	
GROUNDINGLUG	FOR EXISTING FLUSH MOUNT	
FLUSHMTSSCUP	INCL. STAINLESS STEEL CONTAINMENT CUP TO ALLOW FOR FLUSHMOUNT REPLACEMENT	
		960
		40
		1650

PRODUCT ANATOMY

OCEAN MASTER CANTILEVER



FLAG-SHIP



POWDER COAT



PLANTATION ALUMA-TEAK™

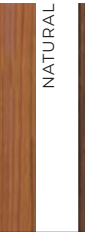
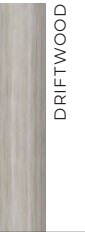
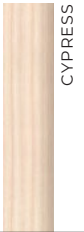

OCEAN MASTER M1 SHADE POD TRIO CANTILEVER

The Ocean Master M1 Shade Pod features from one to four separate canopies supported by a single mast, offering expansive shaded areas. Easily operational with independent auto lift piston systems and locking handles, the Shade Pod allows for deployment of any of the canopies in different directions. **Standard features include:** security stem, polished titanium hub & venice finial.

OCEAN MASTER M1 SHADE POD TRIO CANTILEVER			STANDARD INCLUDED					FINISH UPGRADE 2600	CANOPY ENHANCEMENT				COVER BAG 720	ANCHOR WEIGHT							
			FABRIC	VENT	PROFILE	LIFT	FINISH		1405	2980	2980	2730									
 LIST PRICE EUR			ALL MXT SERIES, SEE PAGE 133 FOR DETAILS & OTHER OPTIONS.					SINGLE WIND VENT (MATCHING STANDARD, CONTRASTING OPTION)	MARKET CUT PROFILE	MANUAL PISTON ASSISTED LIFT NON-TELESCOPING, MAY NOT CLOSE OVER TABLE	POWDER COAT OPTIONS: SEE PAGE 67 FOR DETAILS *	PLANTATION ALUMA-TEAK™ OPTIONS: SEE PAGE 67 FOR DETAILS				CONTRASTING BINDING (CANOPY AND VENT)	15CM ACCENT BORDER ON CANOPY	VALANCE (STRAIGHT, SCALLOPED, CLASSIC OR MODERN ROMAN)	15CM CORD FRINGE	CUSTOM PROTECTIVE COVER (PRICE IS PER COVER)	MINIMUM RECOMMENDED WEIGHT
			LEVEL C									PP. 142-143 FOR MORE ENHANCEMENTS									
SQUARE																					
SPD8.0SQ	8.0' / 2.45M	13465	INCL	INCL	INCL	INCL	INCL	o	o	o	o	o	CSP1	180KG							
SPD10.0SQ	10.0' / 3M	15860	INCL	INCL	INCL	INCL	INCL	o	o	o	o	o	CSP2	180KG							

OCEAN MASTER M1 SHADE POD QUAD CANTILEVER

OCEAN MASTER M1 SHADE POD QUAD CANTILEVER			STANDARD INCLUDED					FINISH UPGRADE 3210	CANOPY ENHANCEMENT				COVER BAG 720	ANCHOR WEIGHT							
			FABRIC	VENT	PROFILE	LIFT	FINISH		1870	3975	3975	3640									
 LIST PRICE EUR			ALL MXT SERIES, SEE PAGE 133 FOR DETAILS & OTHER OPTIONS.					SINGLE WIND VENT (MATCHING STANDARD, CONTRASTING OPTION)	MARKET CUT PROFILE	MANUAL PISTON ASSISTED LIFT NON-TELESCOPING, MAY NOT CLOSE OVER TABLE	POWDER COAT OPTIONS: SEE PAGE 67 FOR DETAILS *	PLANTATION ALUMA-TEAK™ OPTIONS: SEE PAGE 67 FOR DETAILS				CONTRASTING BINDING (CANOPY AND VENT)	15CM ACCENT BORDER ON CANOPY	VALANCE (STRAIGHT, SCALLOPED, CLASSIC OR MODERN ROMAN)	15CM CORD FRINGE	CUSTOM PROTECTIVE COVER (PRICE IS PER COVER)	MINIMUM RECOMMENDED WEIGHT
			LEVEL C									PP. 142-143 FOR MORE ENHANCEMENTS									
SQUARE																					
SPD8.0SQ	8.0' / 2.45M	17305	INCL	INCL	INCL	INCL	INCL	o	o	o	o	o	CSP1	180KG							
SPD10.0SQ	10.0' / 3M	20490	INCL	INCL	INCL	INCL	INCL	o	o	o	o	o	CSP2	270KG							

* Shade Pods are **not** available in Polished Titanium.

ABOVE GROUND SHADE ANCHORS OVERVIEW & PRICING

HALF ALUMA-CRETE CUBE ANCHOR

ALL M1 CANTILEVER PARASOLS SHIP WITH STAINLESS STEEL SECURITY STEM & BEAUTY COVER.
TOLERANCES +/- 4.5KG / 10 LBS

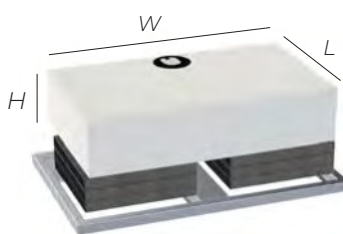
HALF ALUMA-CRETE CUBE ANCHOR			FINISH	FINISH UPGRADE
 <p>L: 68cm W: 116cm H: 20cm</p>		LIST PRICE EUR	POWDER COAT OPTIONS: SEE PAGE 71 MARINE SILVER NOT AVAILABLE	PLANTATION ALUMA-TEAK SEE PAGE 71
AGSP2	COMPLETE ASSEMBLY: HALF FRAME, PAVERS & COVER 236 KG / 520.5 LBS - 6 PAVERS	1985	INCL	330
AGSP2	COMPLETE ASSEMBLY: HALF FRAME, PAVERS & COVER 296 KG / 652.5 LBS - 8 PAVERS	2155	INCL	330
AGSP2	COMPLETE ASSEMBLY: HALF FRAME, PAVERS & COVER 351 KG / 773.5 LBS - 8 PAVERS + 2 G-PLATES	2685	INCL	330

HALF CUBE CUSHION

UPHOLSTERED OPEN CELL FOAM.

HALF CUBE CUSHION			FABRIC		FABRIC UPGRADE
 <p>L: 68cm W: 116cm H: 20cm</p>		LIST PRICE EUR	CXT & LXT SERIES. LEVEL B SEE PAGE 133 FOR DETAILS	ALL MXT SERIES. LEVEL C SEE PAGE 133 FOR DETAILS	ALL PXT SERIES. LEVEL E SEE PAGE 133 FOR DETAILS
AGSP2-HCC	HALF CUBE CUSHION ONLY	1350	INCL	INCL	20%

ABOVE GROUND SHADE ANCHORS OVERVIEW & PRICING

FULL ALUMA-CRETE CUBE ANCHOR

ALL M1 CANTILEVER PARASOLS SHIP WITH STAINLESS STEEL SECURITY STEM & BEAUTY COVER.
TOLERANCES +/- 4.5KG / 10 LBS

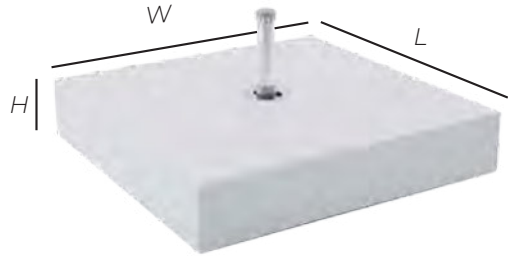
FULL ALUMA-CRETE CUBE ANCHOR			FINISH	
 <p>L: 116cm W: 116cm H: 20cm</p>		LIST PRICE EUR	POWDER COAT OPTIONS: SEE BELOW. MARINE SILVER NOT AVAILABLE.	
AGSP	COMPLETE ASSEMBLY: FULL FRAME, PAVERS & COVER 317 KG / 700 LBS - 8 PAVERS		2415	INCL
AGSP	COMPLETE ASSEMBLY: FULL FRAME, PAVERS & COVER 437 KG / 963.5 LBS - 12 PAVERS	2760	INCL	

FULL CUBE CUSHION

UPHOLSTERED OPEN CELL FOAM.

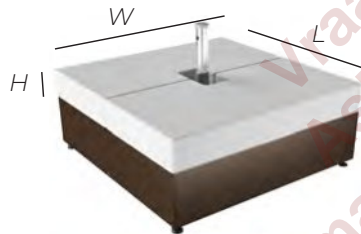
FULL CUBE CUSHION		FABRIC		FABRIC UPGRADE
 <p>L: 116cm W: 116cm H: 20cm</p>		LIST PRICE EUR	CXT & LXT SERIES, LEVEL B SEE PAGE 133 FOR DETAILS	ALL PXT SERIES, LEVEL C SEE PAGE 133 FOR DETAILS
AGSP-FCC	FULL CUBE CUSHION ONLY		2350	INCL
				20%

FINISHES

Plantation Aluma-TEAK™

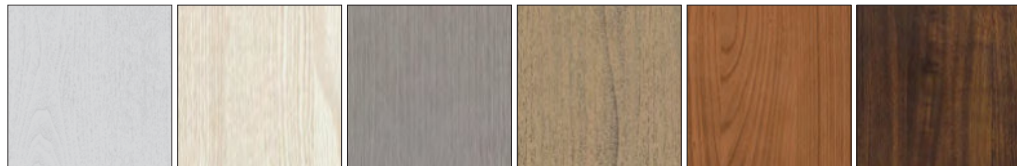

Aspen White Cypress Driftwood Weathered Natural Java

Powder Coat



Marine Silver Silver Sand Glacier White Sandbar Oyster Night Fog Espresso Graphite Black Sea

ABOVE GROUND SHADE ANCHORS OVERVIEW & PRICING

G-PLATE ANCHORS

GALVANIZED STEEL WITH STAINLESS STEEL SECURITY STEM.

ALL M1 CANTILEVER PARASOLS SHIP WITH STAINLESS STEEL SECURITY STEM & BEAUTY COVER. TOLERANCES +/- 4.5 KG / 10 LBS

G-PLATE ANCHORS		LIST PRICE EUR	FINISH	ANCHOR COVERS (TOP G-PLATE ONLY)		TUFF WHEELS
				POWDER COAT OPTIONS: SEE PAGE 71 MARINE SILVER NOT AVAILABLE.	PLANTATION ALUMA-TEAK OPTIONS: SEE PAGE 71	
GV36SQ	91 KG / 200 LBS. 91CM / 36.0" SQUARE	1025	INCL	365	445	405
GV30+30SQ	127 KG / 280 LBS. 76CM / 30.0" SQUARE DOUBLE-STACK	1455	INCL	365	445	405
GV36+36SQ	181 KG / 400 LBS. 91CM / 36.0" SQUARE DOUBLE-STACK	2050	INCL	365	445	405
GV36X3SQ	272 KG / 600 LBS. 91CM / 36.0" SQUARE TRIPLE-STACK	3075	INCL	365	445	405
GV36X4SQ	363 KG / 800 LBS. 91CM / 36.0" SQUARE QUAD-STACK	4100	INCL	365	445	405

TUFF WHEELS



ANCHOR COVER -
POWDER COAT



ANCHOR COVER -
PLANTATION ALUMA-TEAK



ABOVE GROUND ANCHOR INSTALLATION PROCESS



BEAUTY COVER
INCLUDED TO
CONCEAL HARDWARE



ALUMA-CRETE ANCHOR



G-PLATE ANCHOR



LEVER LOCKS PARASOLS
INTO STEM AFFIXED TO
ANCHOR



CAM LOCK LEVER ALLOWS
360° ROTATION. CENTER
POST AFFIXES TO SECURITY
STEM USING LEVEL



G-PLATE ANCHORS WITH A
COVER.

IN GROUND SHADE ANCHORS OVERVIEW & PRICING

IN GROUND SECURITY MOUNT ANCHOR

COMPATIBLE WITH ALL M1 CANTILEVER ANCHOR STEMS.
ALL M1 CANTILEVER PARASOLS SHIP WITH STAINLESS STEEL SECURITY STEM & BEAUTY COVER.

FOR USE IN NEW POUR CONCRETE		
		LIST PRICE EUR
IGSM	INSTALLATION PROCESS DEPICTED ABOVE	

STAINLESS STEEL SURFACE ANCHOR

COMPATIBLE WITH ALL M1 CANTILEVER ANCHOR STEMS. INCLUDES 8 DROP-IN EXPANSION ANCHORS. THE SURFACE ANCHOR REQUIRES 4,000 PSI CONCRETE THAT IS AT LEAST 10CM / 4" DEEP FOR PROPER INSTALLATION. ALL M1 CANTILEVER PARASOLS SHIP WITH STAINLESS STEEL SECURITY STEM & BEAUTY COVER.

FOR USE ON EXISTING CONCRETE PAD		
		LIST PRICE EUR
MAXPLATE	INSTALLATION PROCESS DEPICTED ABOVE	

SHADE ANCHORS ACCESSORIES & PRICING

M1 EXTENSION & ALUMINUM COVER

FOR USE WITH ALL M1 CANTILEVER ANCHOR STEMS.
ORDER IN ANY INCREMENT FROM 10CM - 40CM / 4" - 16"

STANDARD FINISH IS SILVER SAND. INDICATE PARASOL SIZE & STYLE.

STAINLESS STEEL EXTENSION	XPRESS	
	LIST PRICE EUR	XPRESS SHIPPING
BASE-EXT	750	950

ALUMINUM EXTENSION COVER	FINISH	FINISH UPGRADE
	POWDER COAT OPTIONS: SEE PAGE 71 MARINE SILVER NOT AVAILABLE	PLANTATION ALUMA-TEAK OPTIONS: SEE PAGE 71
BASE-EXTCV	INCL	185

PRODUCT ANATOMY

BAY MASTER

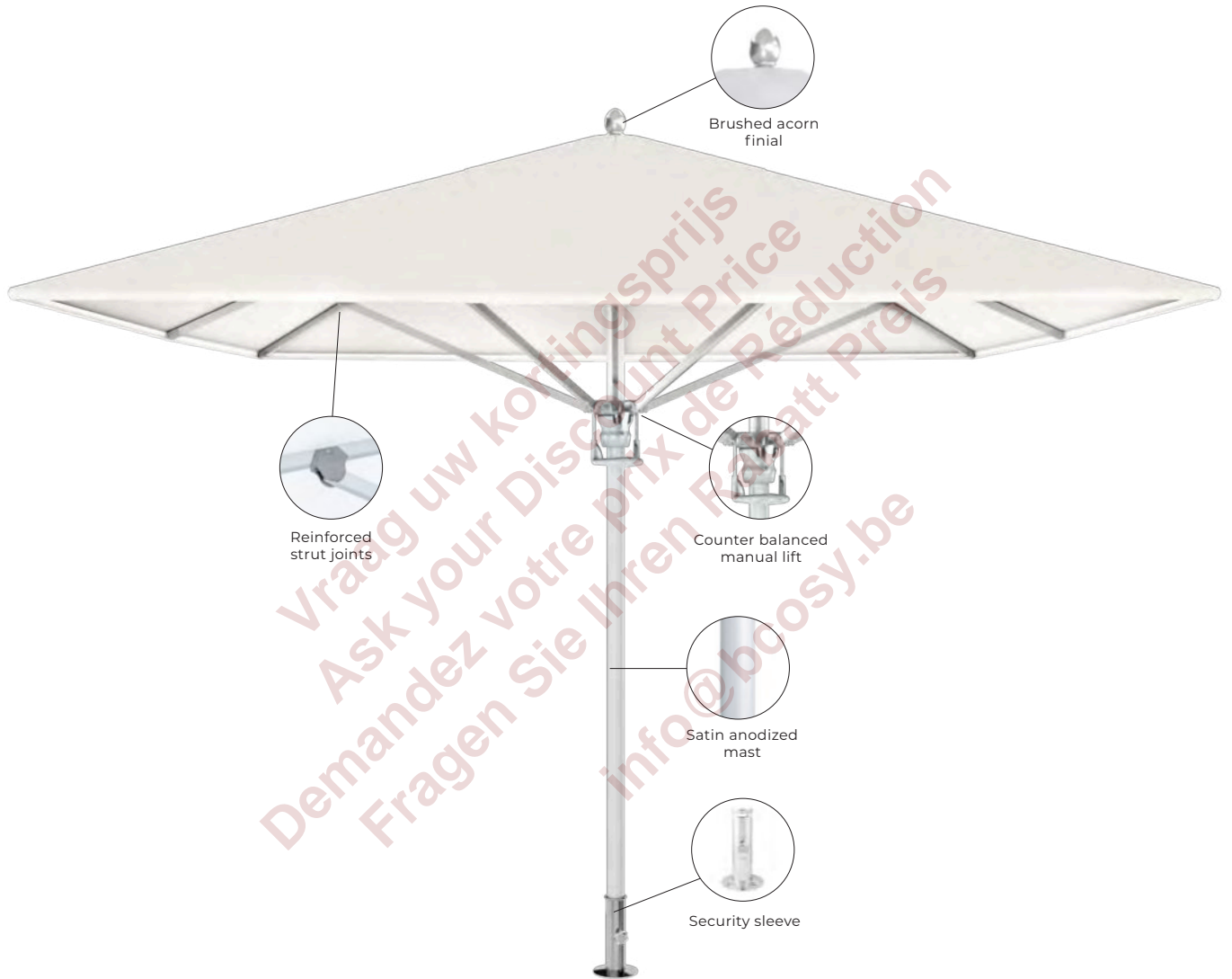

CLASSIC



PRODUCT OVERVIEW & PRICING

BAY MASTER MAX CLASSIC

The Bay Master MAX Classic is flexible and lightweight, built to gracefully withstand the high winds, blazing sun, and corrosive salt air of coastal settings. Inherently resistant to rust and corrosion, the Bay Master MAX Classic is perfect for beach concessionaires, restaurants, and poolside settings. **Standard features include:** stainless steel security sleeve, mast diameter of 60mm / 2-3/8" and brushed acorn finial.

BAY MASTER MAX CLASSIC			STANDARD INCLUDED					FABRIC UPGRADE	CANOPY ENHANCEMENT		COVER BAG	ANCHOR
			FABRIC	VENT	PROFILE	LIFT	FINISH	+10%	680	910	720	WEIGHT
			LIST PRICE EUR CXT & LXT SERIES. SEE PAGE 133 FOR DETAILS & OTHER OPTIONS.	SINGLE WIND VENT	MARKET CUT PROFILE	COUNTER BALANCED MANUAL LIFT WITH TELESCOPING MAST	SATIN ANODIZED	ALL MXT SERIES. SEE PAGE 133 FOR DETAILS.	VALANCE (STRAIGHT, SCALLOPED, CLASSIC OR MODERN ROMAN) 15CM CORD FRINGE	CUSTOM PROTECTIVE COVER	MINIMUM RECOMMENDED WEIGHT	
SQUARE			LEVEL B					LEVEL C	PP. 142-143 FOR MORE ENHANCEMENTS			
BMX10.0SQ	10.0' / 3.0M	3690	INCL	INCL	INCL	INCL	INCL	o	o	o	CX2	64KG
BMX13.0SQ	13.0' / 4.0M	4730	INCL	INCL	INCL	INCL	INCL	o	o	o	CX4	90KG
OCTAGON			LEVEL B					LEVEL C	PP. 142-143 FOR MORE ENHANCEMENTS			
BMX14.0OCT	14.0' / 4.25M	4730	INCL	INCL	INCL	INCL	INCL	o	o	o	CX4	90KG

PRODUCT UPGRADES

BAY MASTER MAX LIGHTNING

NOTE: LIGHT OPTION NEEDS TO BE SELECTED AT THE TIME THE BAY MASTER MAX PARASOL IS ORDERED AS INSTALLATION IS PART OF THE MANUFACTURING PROCESS. LIGHTING FEATURES INCLUDE: 1USA=110V & 220V= EUROPE, TOTAL OF 4, 12V DC AMBIENT LIGHT FIXTURES. SOFT WHITE COLOR. ON/OFF TOUCH SWITCH.

P2	LIGHTS ONLY (Telescoping mast)	LIST PRICE EUR 1065
----	-----------------------------------	------------------------

ABOVE GROUND SHADE ANCHORS OVERVIEW & PRICING

G-PLATE ANCHORS

GALVANIZED STEEL WITH BAY MASTER MAX DECK MOUNT.
DECK MOUNT SHIPS WITH THE PARASOL. TOLERANCES +/- 4.5 KG / 10 LBS

G-PLATE ANCHORS		LIST PRICE EUR	FINISH	ANCHOR COVERS (TOP G-PLATE ONLY)		TUFF WHEELS
			GALVANIZED STEEL	POWDER COAT OPTIONS: SEE BELOW. MARINE SILVER NOT AVAILABLE	PLANTATION ALUMA-TEAK OPTIONS: SEE BELOW	1 SET OF 4 WHEELS
GV36SQ	91 KG / 200 LBS. 91CM / 36.0" SQUARE	1025	INCL	365	445	405
GV36+36SQ	181 KG / 400 LBS. 91CM / 36.0" SQUARE DOUBLE-STACK	2050	INCL	365	445	405
GV36X3SQ	272 KG / 600 LBS. 91CM / 36.0" SQUARE TRIPLE-STACK	3075	INCL	365	445	405

ALUMA-CRETE ROUND

ALUMINIUM, CONCRETE FILLED, FOUR HOLE VERSION.
NOT RECOMMENDED FOR USE WITH PARASOLS LARGER THAN 10' / 3M SQ.
BAY MASTER MAX PARASOLS SHIP WITH STAINLESS STEEL SECURITY SLEEVE, TOLERANCES +/- 4.5 KG / 10 LBS

ALUMA-CRETE ROUND ANCHORS		LIST PRICE EUR	FINISH	FINISH UPGRADE
			POWDER COAT OPTIONS: SEE BELOW	PLANTATION ALUMA-TEAK OPTIONS: SEE BELOW
ACF200	86 KG / 200 LBS. 76CM / 30.0" DIAMETER	820	INCL	230
ACF250	109 KG / 250 LBS. 84CM / 33.0" DIAMETER	930	INCL	230

FINISHES

Plantation Aluma-TEAK™

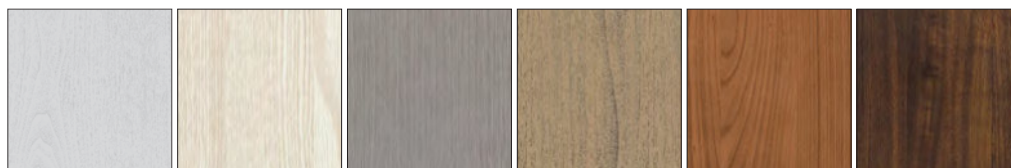

Aspen White Cypress Driftwood Weathered Natural Java

Powder Coat



Marine Silver Silver Sand Glacier White Sandbar Oyster Night Fog Espresso Graphite Black Sea

IN GROUND SHADE ANCHORS OVERVIEW & PRICING

IN GROUND SECURITY MOUNT

BAY MASTER MAX PARASOLS SHIP WITH STAINLESS STEEL SECURITY SLEEVE.

FOR USE IN NEW POUR CONCRETE	
	LIST PRICE EUR
IGSM	670

STAINLESS STEEL SURFACE ANCHOR

INCLUDES 8 DROP-IN EXPANSION ANCHORS. THE SURFACE ANCHOR REQUIRES 4,000 PSI CONCRETE THAT IS AT LEAST 10CM / 4" DEEP FOR PROPER INSTALLATION. BAY MASTER MAX PARASOLS SHIP WITH STAINLESS STEEL SECURITY SLEEVE.

FOR USE ON EXISTING CONCRETE PAD	
	LIST PRICE EUR
MAXPLATE	895

SHADE ANCHORS ACCESSORIES & PRICING

MAX EXTENSION & ALUMINUM COVER

ORDER IN ANY INCREMENT FROM 10CM - 40CM / 4" - 16".

STAINLESS STEEL EXTENSION		XPRESS
	LIST PRICE EUR	XPRESS SHIPPING
BASE-EXT	750	950

STANDARD FINISH IS SILVER SAND. INDICATE PARASOL SIZE & STYLE.

ALUMINUM EXTENSION COVER		FINISH	FINISH UPGRADE
	LIST PRICE EUR	POWDER COAT OPTIONS: SEE PAGE 79 MARINE SILVER NOT AVAILABLE	PLANTATION ALUMA-TEAK OPTIONS: SEE PAGE 79
BASE-EXTCV	700	INCL	185

PRODUCT ANATOMY

BAY MASTER CENTER POST

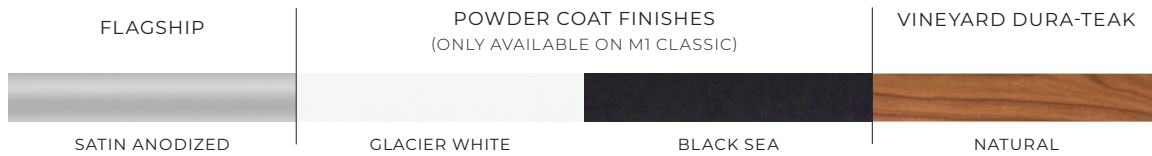
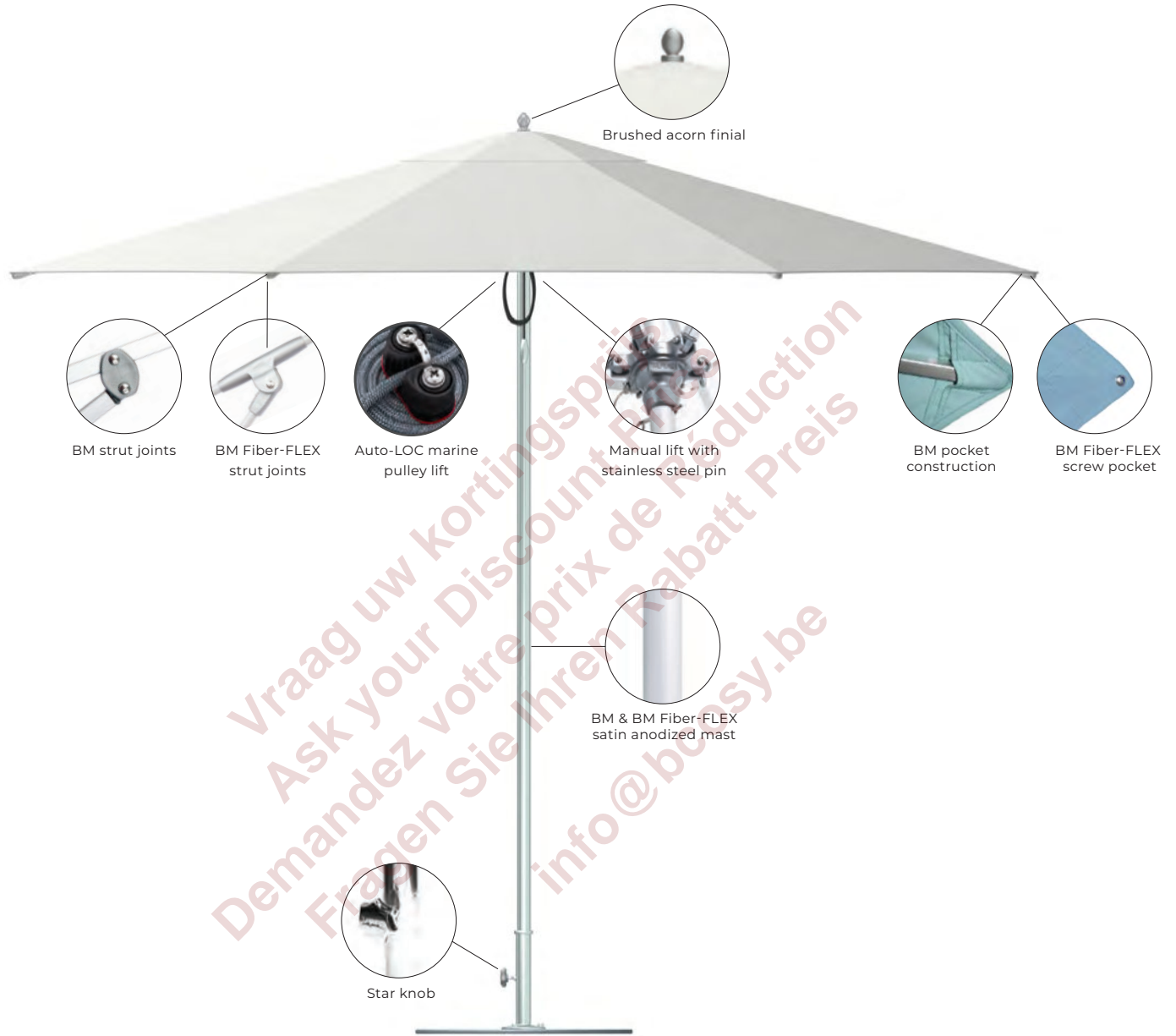





PRODUCT OVERVIEW & PRICING

BAY MASTER M1 CLASSIC

The Bay Master M1 series of parasols with marine grade aluminum struts is our most durable promotional parasol collection. Intended for most commercial settings, this parasol features an extremely durable and rigid aluminum strut system. Proven in high traffic areas, oceanfront installations and exposed street-side locations, the Bay Master M1 Classic is designed to endure challenging weather conditions.

Standard features include: mast diameter of 38.1mm / 1.5" and stainless steel brushed acorn finial. Venice finial available for an additional €30 list. Deduct €150 for manual lift system. Natural Aluma-Teak mast for an additional €155 list.





BAY MASTER M1 CLASSIC			STANDARD INCLUDED					FINISH UPGRADE		FABRIC UP-GRADE	CANOPY ENHANCEMENT	COVER BAG	ANCHOR	
			FABRIC	VENT	PROFILE	LIFT	FINISH	225	445	+10%	250	155	WEIGHT	
 <p>Bay Master M1 Classic ribs</p>		LIST PRICE EUR	CXT & LXT SERIES. SEE PAGE 133 FOR DETAILS & OTHER OPTIONS.	SINGLE WIND VENT (MATCHING STANDARD, CONTRASTING OPTION)	MARKET CUT PROFILE	AUTO-LOC MARINE PULLEY	SATIN ANODIZED	POWDER COAT FINISHES: GLACIER WHITE OR BLACK SEA	VINEYARD DURA-TEAK NATURAL (FIBERGLASS)	ALL MXT SERIES. SEE PAGE 133 FOR DETAILS.	VALANCE (STRAIGHT, SCALLOPED, CLASSIC OR MODERN ROMAN)	STANDARD POLYESTER DARK GREY PROTECTIVE COVER	MINIMUM RECOMMENDED WEIGHT	
SQUARE			LEVEL B								LEVEL C	PP. 142-143 FOR MORE ENHANCEMENTS		
BM5.5SQ	5.5' / 1.65M	1085	INCL	INCL	INCL	INCL	INCL	o	o	o	o	SS3	41KG	
BM6.5SQ	6.5' / 2.0M	1200	INCL	INCL	INCL	INCL	INCL	o	o	o	o	SS3	41KG	
BM7.5SQ	7.5' / 2.25M	1345	INCL	INCL	INCL	INCL	INCL	o	o	o	o	SS3	41KG	
BM8.0SQ	8.0' / 2.4M	1515	INCL	INCL	INCL	INCL	INCL	o	o	o	o	SS3	48KG	
OCTAGON			LEVEL B								LEVEL C	PP. 142-143 FOR MORE ENHANCEMENTS		
BM7.5OCT	7.5' / 2.25M	1515	INCL	INCL	INCL	INCL	INCL	o	o	o	o	SS3	41KG	
BM9.0OCT	9.0' / 2.75M	1595	INCL	INCL	INCL	INCL	INCL	o	o	o	o	SS3	41KG	
BM10.5OCT	10.5' / 3.2M	1800	INCL	INCL	INCL	INCL	INCL	o	o	o	o	SS3	48KG	
HEXAGON			LEVEL B								LEVEL C	PP. 142-143 FOR MORE ENHANCEMENTS		
BM7.0HEX	7.0' / 2.15M	1345	INCL	INCL	INCL	INCL	INCL	o	o	o	o	SS3	34KG	
BM8.5HEX	8.5' / 2.6M	1405	INCL	INCL	INCL	INCL	INCL	o	o	o	o	SS3	48KG	
BM10.0HEX	10.0' / 3.0M	1685	INCL	INCL	INCL	INCL	INCL	o	o	o	o	SS3	48KG	
RECTANGLE			LEVEL B								LEVEL C	PP. 142-143 FOR MORE ENHANCEMENTS		
BM6X9RECT	6.0' X 9.0' / 1.8M X 2.75M	1720	INCL	INCL	INCL	INCL	INCL	o	o	o	o	SS3	48KG	

PRODUCT OVERVIEW & PRICING

BAY MASTER M1 FIBER-FLEX

This parasol is inspired by the wind-swept ocean and desert landscapes of the Baja Peninsula. Tuuci incorporates flexible fiberglass struts—aptly named Fiber-FLEX—which absorb punishing wind conditions, sudden gusts and corrosive salt air environments. Along with Tuuci's patented independent bracket system and our durable Bay Master M1 mast, this parasol is guaranteed to last for years.

Standard features include: mast diameter of 38.1mm / 1.5" and stainless steel brushed acorn finial. Venice finial available for an additional €30 list. Deduct €150 for manual lift system. Natural Aluma-Teak mast for an additional €155 list.

BAY MASTER M1 FIBER-FLEX			STANDARD INCLUDED					FINISH	FABRIC UPGRADE	CANOPY ENHANCEMENT	COVER BAG	ANCHOR
			FABRIC	VENT	PROFILE	LIFT	FINISH	445	+10%	250	155	WEIGHT
 <p>Bay Master M1 Fiber-FLEX ribs</p>			<p>LIST PRICE EUR</p> <p>CXT & LXT SERIES. SEE PAGE 133 FOR DETAILS & OTHER OPTIONS.</p> <p>SINGLE WIND VENT (MATCHING STANDARD, CONTRASTING OPTION)</p> <p>MARKET CUT PROFILE</p> <p>AUTO-LOC MARINE PULLEY</p> <p>SATIN ANODIZED</p>					VINEYARD DURA-TEAK NATURAL (FIBERGLASS)	ALL MXT SERIES. SEE PAGE 133 FOR DETAILS.	VALANCE (STRAIGHT, SCALLOPED, CLASSIC OR MODERN ROMAN)	STANDARD POLYESTER DARK GREY PROTECTIVE COVER	MINIMUM RECOMMENDED WEIGHT
<p>SQUARE</p> 			LEVEL B						LEVEL C	PP. 142-143 FOR MORE ENHANCEMENTS		
BM5.5SQ	5.5' / 1.65M	1085	INCL	INCL	INCL	INCL	INCL	o	o	o	SS3	41KG
BM6.5SQ	6.5' / 2.0M	1200	INCL	INCL	INCL	INCL	INCL	o	o	o	SS3	41KG
BM7.5SQ	7.5' / 2.25M	1345	INCL	INCL	INCL	INCL	INCL	o	o	o	SS3	41KG
<p>OCTAGON</p> 			LEVEL B						LEVEL C	PP. 142-143 FOR MORE ENHANCEMENTS		
BM7.5OCT	7.5' / 2.25M	1345	INCL	INCL	INCL	INCL	INCL	o	o	o	SS3	41KG
BM9.0OCT	9.0' / 2.75M	1595	INCL	INCL	INCL	INCL	INCL	o	o	o	SS3	41KG
BM10.5OCT	10.5' / 3.2M	1800	INCL	INCL	INCL	INCL	INCL	o	o	o	SS3	48KG
<p>HEXAGON</p> 			LEVEL B						LEVEL C	PP. 142-143 FOR MORE ENHANCEMENTS		
BM7.0HEX	7.0' / 2.15M	1345	INCL	INCL	INCL	INCL	INCL	o	o	o	SS3	34KG
BM8.5HEX	8.5' / 2.6M	1405	INCL	INCL	INCL	INCL	INCL	o	o	o	SS3	48KG
BM10.0HEX	10.0' / 3.0M	1685	INCL	INCL	INCL	INCL	INCL	o	o	o	SS3	48KG

PRODUCT ANATOMY

BAY MASTER MARITIME HARDWOOD









PRODUCT OVERVIEW & PRICING

BAY MASTER M1 MARITIME HARDWOOD

As part of the Essential Collection, Tuuci's line of elegant shade parasols, where old-world craftsmanship is perfectly matched with modern corrosion-proof materials, the Bay Master M1 Maritime Hardwood is consistently a top parasol choice for luxury resorts throughout the world and for good reason; it's able to withstand tough, windy conditions in tropical climates. Tuuci's proprietary stainless steel non-expansion sleeves prevent the center pole, made from long-grain hardwood, from swelling. This unique feature allows the ribs to breathe, instead of break, in gusty conditions, ensuring years of uninterrupted service.

Standard features include: solid maritime hardwood hub with stainless steel banded bracket system, tumbled leather and linseed oil finish and brushed acorn finial. Deduct €100 for double pulley with pin lift. Deduct €150 for manual lift system. Venice finial available for an additional €30 list.

BAY MASTER M1 MARITIME HARDWOOD				STANDARD INCLUDED					FABRIC UPGRADE +10%	CANOPY ENHANCEMENT		COVER BAG		ANCHOR													
				FABRIC	VENT	PROFILE	LIFT	FINISH		250	115	155	510	WEIGHT													
		MAST DIAMETER IN MM		LIST PRICE EUR		CXT & LXT SERIES - SEE PAGE 133 FOR DETAILS & OTHER OPTIONS.		SINGLE WIND VENT		MARKET CUT PROFILE		AUTO-LOC MARINE PULLEY		NATURAL		ALL MXT SERIES - SEE PAGE 133 FOR DETAILS.		VALANCE (STRAIGHT, SCALLOPED, CLASSIC OR MODERN ROMAN)		DOUBLE WIND VENT (NOT OFFERED ON SQUARE)		STANDARD POLYESTER DARK GREY PROTECTIVE COVER		CUSTOM PROTECTIVE COVER		MINIMUM RECOMMENDED WEIGHT	
		SQUARE 				LEVEL B		LEVEL C		PP. 142-143 FOR MORE ENHANCEMENTS																	
MS6.5SQ	6.5' / 2.0M	47.6MM	1445	o	INCL	INCL	INCL	INCL	o	o	—	SS3	CS3	41KG													
OCTAGON 				LEVEL B		LEVEL C		PP. 142-143 FOR MORE ENHANCEMENTS																			
MS9.0OCT	9.0' / 2.75M	47.6MM	1930	o	INCL	INCL	INCL	INCL	o	o	o	SS3	CS3	41KG													
HEXAGON 				LEVEL B		LEVEL C		PP. 142-143 FOR MORE ENHANCEMENTS																			
MS8.5HEX	8.5' / 2.6M	47.6MM	1615	o	INCL	INCL	INCL	INCL	o	o	o	SS3	CS3	48KG													

* The Bay Master M1 Maritime Hardwood models are only available with a 51mm / 2.0" Stainless Steel Security Sleeve - Deck Mount. See page 91 for the upcharge.

ABOVE GROUND SHADE ANCHORS OVERVIEW & PRICING

ALUMA-CRETE ROUND

ALUMINIUM, CONCRETE FILLED SHELL, FOUR HOLE VERSION WITH STAINLESS STEEL SECURITY SLEEVE.
SIZES REFER TO THE DIAMETER OF THE PARASOL MAST. EXAMPLE: FOR A 38.1MM / 1.5" MAST, SELECT A 38.1MM / 1.5" SECURITY SLEEVE.
TOLERANCES +/- 4.5 KG / 10 LBS

ALUMA-CRETE ROUND - STANDARD			FINISH	SECURITY SLEEVE	FINISH UPGRADE	SECURITY SLEEVE UPGRADE				SECURITY SLEEVE FINISH UPGRADE						
	STAINLESS STEEL SECURITY SLEEVE	LIST PRICE EUR	MARINE SILVER (STANDARD) POWDER COAT OPTIONS: SEE BELOW	38.1MM / 1.5" SECURITY SLEEVE	PLANTATION ALUMA-TEAK OPTIONS: SEE BELOW	44MM / 1.75" SECURITY SLEEVE	51MM / 2.0" SECURITY SLEEVE	57MM / 2.25" SECURITY SLEEVE	44MM / 1.75" SECURITY SLEEVE WITH EXTENSION (FOR 38.1MM / 1.5" MAST)	38.1MM / 1.5" AUTO-CAM LOCK SECURITY SLEEVE	POWDER COAT OPTIONS ONLY: SEE BELOW MARINE SILVER NOT AVAILABLE					
ACFW95	43 KG / 95 LBS. 61CM / 24.0" DIAMETER					505	INCL	INCL	145	40		70	—	90	115	45
ACFW150	68 KG / 150 LBS. 71CM / 28.0" DIAMETER					570	INCL	INCL	145	40		70	105	90	115	45

ALUMA-CRETE ROUND - WITH LIFT HANDLES			FINISH	SECURITY SLEEVE	FINISH UPGRADE	SECURITY SLEEVE UPGRADE				SECURITY SLEEVE FINISH UPGRADE						
	STAINLESS STEEL SECURITY SLEEVE	LIST PRICE EUR	MARINE SILVER (STANDARD) POWDER COAT OPTIONS: SEE BELOW	38.1MM / 1.5" SECURITY SLEEVE	PLANTATION ALUMA-TEAK OPTIONS: SEE BELOW	44MM / 1.75" SECURITY SLEEVE	51MM / 2.0" SECURITY SLEEVE	57MM / 2.25" SECURITY SLEEVE	44MM / 1.75" SECURITY SLEEVE WITH EXTENSION (FOR 38.1MM / 1.5" MAST)	38.1MM / 1.5" AUTO-CAM LOCK SECURITY SLEEVE	POWDER COAT OPTIONS ONLY: SEE BELOW MARINE SILVER NOT AVAILABLE					
ACF200	91 KG / 200 LBS. 76CM / 30.0" DIAMETER					820	INCL	INCL	230	40		70	105	90	115	45
ACF250	109 KG / 250 LBS. 84CM / 33.0" DIAMETER					930	INCL	INCL	230	40		70	105	90	115	45

STAINLESS STEEL WHEEL TRAY



TUFF WHEELS



ANCHOR COVER - POWDER COAT



ANCHOR COVER - PLANTATION ALUMA-TEAK



FINISHES

Plantation Aluma-TEAK™

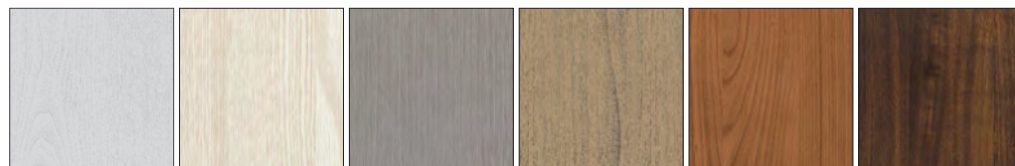

Aspen White Cypress Driftwood Weathered Natural Java

Powder Coat





Marine Silver Silver Sand Glacier White Sandbar Oyster Night Fog Espresso Graphite Black Sea

ABOVE GROUND SHADE ANCHORS OVERVIEW & PRICING

G-PLATE ANCHORS

GALVANIZED STEEL WITH STAINLESS STEEL SECURITY SLEEVE. SIZES REFER TO THE DIAMETER OF THE PARASOL MAST. EXAMPLE: FOR A 38.1MM / 1.5" MAST, SELECT A 38.1MM / 1.5" SECURITY SLEEVE. G-PLATES AND COVERS HAVE FOUR HOLE PATTERN.
TOLERANCES +/- 4.5 KG / 10 LBS

G-PLATE ROUND		LIST PRICE EUR	FINISH	SECURITY SLEEVE	ANCHOR COVERS (FOR TOP G-PLATE ONLY)		SECURITY SLEEVE UPGRADE					SECURITY SLEEVE FINISH UPGRADE	WHEEL TRAY
			GALVANIZED STEEL	38.1MM / 1.5" SECURITY SLEEVE	POWDER COAT OPTIONS: SEE PAGE 88. MARINE SILVER NOT AVAILABLE	PLANTATION ALUMA-TEAK OPTIONS: SEE PAGE 88	44MM / 1.75" SECURITY SLEEVE	51MM / 2.0" SECURITY SLEEVE	57MM / 2.25" SECURITY SLEEVE	44MM / 1.75" SECURITY SLEEVE WITH EXTENSION (FOR 38.1MM / 1.5" MAST)	38.1MM / 1.5" AUTO-CAM LOCK SECURITY SLEEVE	POWDER COAT OPTIONS ONLY: SEE PAGE 88. MARINE SILVER NOT AVAILABLE	STAINLESS STEEL WHEEL TRAY (FOR USE WITH ROUND G-PLATES)
GV24RND	34 KG / 75 LBS. 61CM / 24.0" DIAMETER	595	INCL	INCL	240	285	40	70	—	90	115	45	295
GV30RND	48 KG / 105 LBS. 76CM / 30.0" DIAMETER	765	INCL	INCL	240	285	40	70	105	90	115	45	295

G-PLATE ROUND - DOUBLE STACK		LIST PRICE EUR	FINISH	SECURITY SLEEVE	ANCHOR COVERS (FOR TOP G-PLATE ONLY)		SECURITY SLEEVE UPGRADE					SECURITY SLEEVE FINISH UPGRADE	WHEEL TRAY
			GALVANIZED STEEL	38.1MM / 1.5" SECURITY SLEEVE	POWDER COAT OPTIONS: SEE PAGE 88. MARINE SILVER NOT AVAILABLE	PLANTATION ALUMA-TEAK OPTIONS: SEE PAGE 88	44MM / 1.75" SECURITY SLEEVE	51MM / 2.0" SECURITY SLEEVE	57MM / 2.25" SECURITY SLEEVE	44MM / 1.75" SECURITY SLEEVE WITH EXTENSION (FOR 38.1MM / 1.5" MAST)	38.1MM / 1.5" AUTO-CAM LOCK SECURITY SLEEVE	POWDER COAT OPTIONS ONLY: SEE PAGE 88. MARINE SILVER NOT AVAILABLE	STAINLESS STEEL WHEEL TRAY (FOR USE WITH ROUND G-PLATES)
CV18+30R	66 KG / 145 LBS. 76CM / 30.0" DIAMETER	960	INCL	INCL	—	—	40	70	—	90	115	45	295
GV24+30R	82 KG / 180 LBS. 76CM / 30.0" DIAMETER	1130	INCL	INCL	—	—	40	70	105	90	115	45	295
GV30+30R	95 KG / 210 LBS. 76CM / 30.0" DIAMETER	1300	INCL	INCL	240	285	40	70	105	90	115	45	295

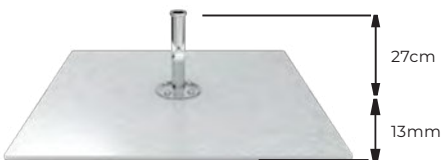
G-PLATE SQUARE		LIST PRICE EUR	FINISH	SECURITY SLEEVE	ANCHOR COVERS (FOR TOP G-PLATE ONLY)		SECURITY SLEEVE UPGRADE					SECURITY SLEEVE FINISH UPGRADE	TUFF WHEEL
			GALVANIZED STEEL	38.1MM / 1.5" SECURITY SLEEVE	POWDER COAT OPTIONS: SEE PAGE 88. MARINE SILVER NOT AVAILABLE	PLANTATION ALUMA-TEAK OPTIONS: SEE PAGE 88	44MM / 1.75" SECURITY SLEEVE	51MM / 2.0" SECURITY SLEEVE	57MM / 2.25" SECURITY SLEEVE	44MM / 1.75" SECURITY SLEEVE WITH EXTENSION (FOR 38.1MM / 1.5" MAST)	38.1MM / 1.5" AUTO-CAM LOCK SECURITY SLEEVE	POWDER COAT OPTIONS ONLY: SEE PAGE 88. MARINE SILVER NOT AVAILABLE	1 SET OF 4 WHEELS
GV24SQ	41 KG / 90 LBS. 61CM / 24.0" SQUARE	685	INCL	INCL	240	285	40	70	105	90	115	45	—
GV30SQ	64 KG / 135 LBS. 76CM / 30.0" SQUARE	955	INCL	INCL	365	445	40	70	105	90	115	45	405
GV24+24SQ	82 KG / 180 LBS. 61CM / 24.0" SQUARE	1145	INCL	INCL	240	285	40	70	105	90	115	45	—
GV36SQ	90 KG / 200 LBS. 90CM / 36.0" SQUARE	1255	INCL	INCL	365	445	40	70	105	90	115	45	405

IN GROUND SHADE ANCHORS OVERVIEW & PRICING

STAINLESS STEEL FLUSH MOUNT WITH CONCRETE CYLINDER

FOR SOFT SURFACES AND PAVERS. INCLUDES 61CM / 24" ALUMINUM EXTENSION SLEEVE FOR USE WITH A 38.1MM / 1.5" MAST. CONCRETE CYLINDER WEIGHS 50 KG / 110 LBS. TOLERANCES +/- 4.5 KG / 10 LBS

FOR USE IN NEW POUR CONCRETE, SOIL OR SAND		
 <p>30,5cm</p> <p>37,5 cm</p>		<p>LIST PRICE EUR</p>
<p>SSFMC</p>	<p>INSTALLATION PROCESS DEPICTED ABOVE</p>	

STAINLESS STEEL FLUSH MOUNT

FOR CONCRETE INSTALLATIONS: INCLUDES 3 DROP-IN ANCHOR BOLTS. 44.5MM / 1.75" DIAMETER STAINLESS STEEL FLUSH MOUNT. INCLUDES 61CM / 24" ALUMINUM EXTENSION SLEEVE FOR USE WITH A 38.1MM / 1.5" MAST.

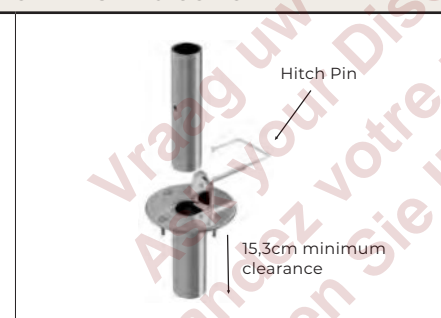
FOR USE ON EXISTING CONCRETE PAD		
 <p>15,3cm</p>	 <p>Hitch Pin</p> <p>15,3cm minimum clearance</p>	<p>LIST PRICE EUR</p>
<p>FLUSHMT</p>	<p>INSTALLATION PROCESS DEPICTED ABOVE</p>	

SHADE ANCHORS ACCESSORIES & PRICING

ACCESSORIES

THE STANDARD IS THE 38.1MM / 1.5" SECURITY SLEEVE. UPGRADING TO A LARGER SIZE HAS AN UPCHARGE. FOR CONCRETE INSTALLATIONS: INCL. 4 DROP-IN ANCHOR BOLTS

STAINLESS STEEL SECURITY SLEEVE - DECK MOUNTS			
	Installation Process	Auto Cam-Lock Security Sleeve	LIST PRICE EUR
			
DECKMNT	38.1MM / 1.5" SECURITY SLEEVE		230
DECKMNT	44MM / 1.75" SECURITY SLEEVE		+40
DECKMNT	51MM / 2.0" SECURITY SLEEVE		+70
DECKMNT	57MM / 2.25" SECURITY SLEEVE		+105
DECKMNT	38.1MM / 1.5" AUTO-CAM LOCK SECURITY SLEEVE		+115

FOR USE WITH 38.1MM / 1.5" MASTS. INCLUDES A STAINLESS STEEL HITCH PIN.

ALUMINUM SAND ANCHOR		LIST PRICE EUR
		
SANDANCHOR		150

FOR USE WITH AUTO-LOC MARINE PULLEY LIFT SYSTEM.

SECOND ROPE HOOK		LIST PRICE EUR
		
ROPEHOOK		85

6.35MM / 1/4" HOLE NEEDED IN MAST TO UTILIZE EXTENSION SLEEVE. 6.35MM / 1/4" DRILL BIT REQUIRED.

ADJUSTABLE EXTENSION SLEEVE WITH HITCH PIN		
		LIST PRICE EUR
EXTPOLE	ALUMINUM EXTENSION SLEEVE 24" LONG X 1.75" DIA. REQUIRES 1.75" SECURITY SLEEVE OR 1.75" STAINLESS STEEL FLUSHMOUNT	100
SSEXTPOLE	STAINLESS STEEL EXTENSION SLEEVE 24" LONG X 1.75" DIA. REQUIRES 1.75" SECURITY SLEEVE OR BASE FOR HIGHLY CORROSIVE INSTALLATIONS INCLUDING POOLS	340

PRODUCT ANATOMY

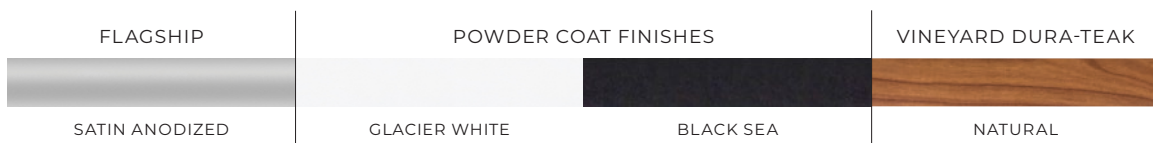
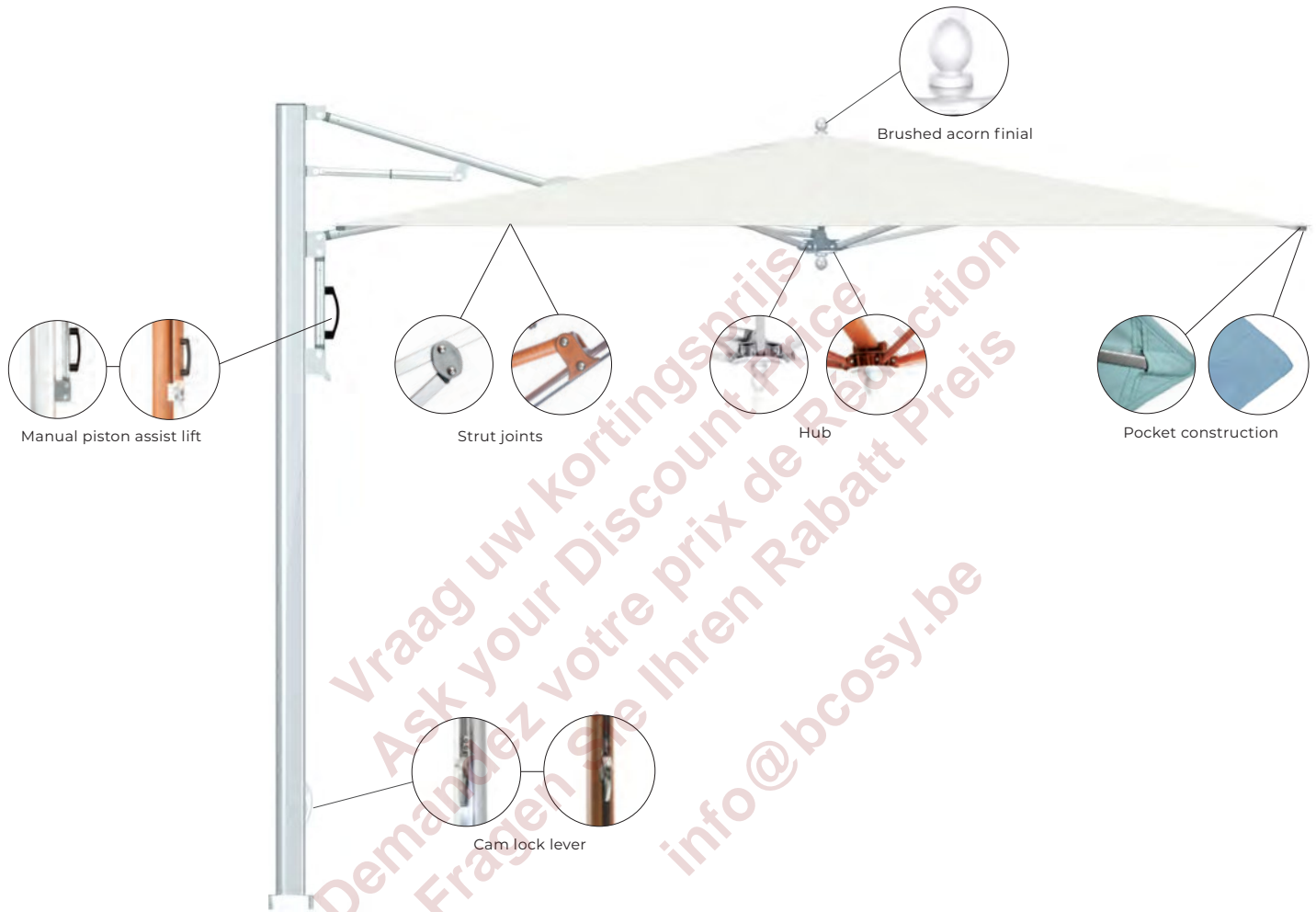

BAY MASTER CANTILEVER



PRODUCT OVERVIEW & PRICING



BAY MASTER M1 CLASSIC CANTILEVER

The Bay Master M1 Single Cantilever is modestly scaled to include smaller shapes and sizes than the larger and more robust MAX Cantilever range. Featuring stainless steel hardware, aluminum struts and Tuuci's exclusive Lift-Assist shade deployment system, this side post parasol is engineered to complement any outdoor environment. **Standard features include:** security stem, brushed acorn finial.

BAY MASTER M1 CLASSIC CANTILEVER		STANDARD INCLUDED					FINISH UPGRADE		FABRIC UPGRADE	CANOPY ENHANCEMENT	COVER BAG		ANCHOR	
		FABRIC	VENT	PROFILE	LIFT	FINISH	655	930	+10%	995	330	720	WEIGHT	
		LIST PRICE EUR	CXT & LXT SERIES, SEE PAGE 133 FOR DETAILS & OTHER OPTIONS.	SINGLE WIND VENT (MATCHING STANDARD, CONTRASTING OPTION)	MARKET CUT PROFILE	MANUAL PISTON ASSISTED LIFT NON-TELESCOPING, MAY NOT CLOSE OVER TABLE	SATIN ANODIZED	POWDER COAT FINISHES: GLACIER WHITE OR BLACK SEA VINEYARD DURA-TEAK NATURAL	ALL MXT SERIES, SEE PAGE 133 FOR DETAILS.	VALANCE (STRAIGHT, SCALLOPED, CLASSIC OR MODERN ROMAN)	STANDARD POLYESTER DARK GREY PROTECTIVE COVER	CUSTOM PROTECTIVE COVER	MINIMUM RECOMMENDED WEIGHT	
SQUARE			LEVEL B						LEVEL C	PP. 142-143 FOR MORE ENHANCEMENTS				
BMCL8.0SQ	8.0' / 2.45M	4025	INCL	INCL	INCL	INCL	INCL	o	o	o	o	SC2	CC2	90KG
BMCL10.0SQ	10.0' / 3.0M	4610	INCL	INCL	INCL	INCL	INCL	o	o	o	o	SC2	CC2	127KG
OCTAGON			LEVEL B						LEVEL C	PP. 142-143 FOR MORE ENHANCEMENTS				
BMCL9.0OCT	9.0' / 2.75M	4025	INCL	INCL	INCL	INCL	INCL	o	o	o	o	SC2	CC2	90KG
BMCL11.0OCT	11.0' / 3.35M	4610	INCL	INCL	INCL	INCL	INCL	o	o	o	o	SC2	CC2	127KG

BAY MASTER M1 SWIM UNDER CANTILEVER

The Swim Under Cantilever parasol is inspired by the wind-swept ocean and desert landscapes of the Baja Peninsula. The shorter mast allows for deployment directly over pools or patios with in-ground mounts within the base for added security and the parasol features an auto lift system on the back side of the cantilever allowing for easy opening from poolside. **Standard features include:** security stem, brushed acorn finial.

BAY MASTER M1 SWIM UNDER CANTILEVER		STANDARD INCLUDED					FINISH UPGRADE	FABRIC UPGRADE	CANOPY ENHANCEMENT	ANCHOR	
		FABRIC	VENT	PROFILE	LIFT	FINISH	930	+10%	995	WEIGHT	
		LIST PRICE EUR	CXT & LXT SERIES, SEE PAGE 133 FOR DETAILS & OTHER OPTIONS.	SINGLE WIND VENT (MATCHING STANDARD, CONTRASTING OPTION)	MARKET CUT PROFILE	COUNTER BALANCE LIFT SYSTEM	SATIN ANODIZED	VINEYARD DURA-TEAK NATURAL	ALL MXT SERIES, SEE PAGE 133 FOR DETAILS.	VALANCE (STRAIGHT, SCALLOPED, CLASSIC OR MODERN ROMAN)	MINIMUM RECOMMENDED WEIGHT
SQUARE			LEVEL B						LEVEL C	PP. 142-143 FOR MORE ENHANCEMENTS	
BMSWIMCL8.0SQ	8.0/2.45M	6615	INCL	INCL	INCL	INCL	INCL	o	o	o	90KG

ABOVE GROUND SHADE ANCHORS OVERVIEW & PRICING

G-PLATE ANCHORS

GALVANIZED STEEL WITH STAINLESS STEEL SECURITY STEM.
ALL M1 CANTILEVER PARASOLS SHIP WITH STAINLESS STEEL SECURITY STEM & BEAUTY COVER. TOLERANCES +/- 4.5 KG / 10 LBS

G-PLATE ANCHORS		LIST PRICE EUR	FINISH	ANCHOR COVERS (TOP G-PLATE ONLY)		TUFF WHEELS
				POWDER COAT OPTIONS: SEE BELOW. MARINE SILVER NOT AVAILABLE	PLANTATION ALUMA-TEAK OPTIONS: SEE BELOW	
			GALVANIZED STEEL			1 SET OF 4 WHEELS
GV36SQ	91 KG / 200 LBS. 91CM / 36.0" SQUARE	1025	INCL	365	445	405
GV30+30SQ	127 KG / 280 LBS. 76CM / 30.0" SQUARE DOUBLE-STACK	1455	INCL	365	445	405
GV36+36SQ	181 KG / 400 LBS. 91CM / 36.0" SQUARE DOUBLE-STACK	2050	INCL	365	445	405
GV36X3SQ	272 KG / 600 LBS. 91CM / 36.0" SQUARE TRIPLE-STACK	3075	INCL	365	445	405

FINISHES

Plantation Aluma-TEAK™



Aspen White Cypress Driftwood Weathered Natural Java

Powder Coat



Marine Silver Silver Sand Glacier White Sandbar Oyster Night Fog Espresso Graphite Black Sea

ABOVE GROUND ANCHOR INSTALLATION PROCESS

 <i>BEAUTY COVER INCLUDED TO CONCEAL HARDWARE</i>				
ALL M1 CL PARASOLS ARE SHIPPED WITH STAINLESS STEEL SECURITY STEM AND BEAUTY COVER	G-PLATE ANCHOR	LEVER LOCKS PARASOLS INTO STEM AFFIXED TO ANCHOR	CAM LOCK LEVER ALLOWS 360° ROTATION. CENTER POST AFFIXES TO SECURITY STEM USING LEVEL	G-PLATE ANCHORS WITH A COVER.

ABOVE GROUND SHADE ANCHORS OVERVIEW & PRICING

HALF ALUMA-CRETE CUBE ANCHOR

ALL M1 CANTILEVER PARASOLS SHIP WITH STAINLESS STEEL SECURITY STEM & BEAUTY COVER.
NOT FOR USE WITH SIZES GREATER THAN 3.05M / 10.0' SQUARE.
TOLERANCES +/- 4.5KG / 10 LBS

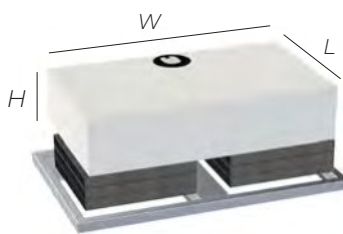
HALF ALUMA-CRETE CUBE ANCHOR		FINISH	FINISH UPGRADE	
 <p>L: 68cm W: 116cm H: 20cm</p>		POWDER COAT OPTIONS: SEE PAGE 95. MARINE SILVER NOT AVAILABLE	PLANTATION ALUMA-TEAK OPTIONS: SEE PAGE 95	
AGSP2	COMPLETE ASSEMBLY: HALF FRAME, PAVERS & COVER 236 KG / 520.5 LBS - 6 PAVERS	1985	INCL	330
AGSP2	COMPLETE ASSEMBLY: HALF FRAME, PAVERS & COVER 296 KG / 652.5 LBS - 8 PAVERS	2155	INCL	330
AGSP2	COMPLETE ASSEMBLY: HALF FRAME, PAVERS & COVER 351 KG / 773.5 LBS - 8 PAVERS + 2 G-PLATES	2685	INCL	330

HALF CUBE CUSHION

UPHOLSTERED OPEN CELL FOAM.

HALF CUBE CUSHION		FABRIC	FABRIC UPGRADE		
 <p>L: 68cm W: 116cm H: 20cm</p>		CXT & LXT SERIES. LEVEL B SEE PAGE 133 FOR DETAILS	ALL MXT SERIES. LEVEL C SEE PAGE 133 FOR DETAILS		
AGSP2-HCC	HALF CUBE CUSHION ONLY	1350	INCL	INCL	20%

IN GROUND SHADE ANCHORS OVERVIEW & PRICING

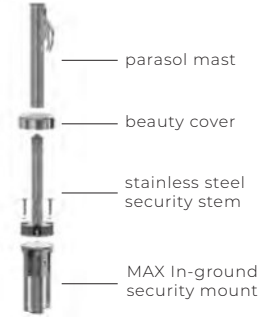

IN GROUND SECURITY MOUNT ANCHOR

COMPATIBLE WITH ALL M1 CANTILEVER ANCHOR STEMS.
ALL M1 CANTILEVER PARASOLS SHIP WITH STAINLESS STEEL SECURITY STEM & BEAUTY COVER.

FOR USE IN NEW POUR CONCRETE		
		LIST PRICE EUR
IGSM	INSTALLATION PROCESS DEPICTED ABOVE	

STAINLESS STEEL SURFACE ANCHOR

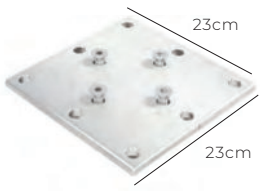
COMPATIBLE WITH ALL M1 CANTILEVER ANCHOR STEMS. INCLUDES 8 DROP-IN EXPANSION ANCHORS. THE SURFACE ANCHOR REQUIRES 4,000 PSI CONCRETE THAT IS AT LEAST 10CM / 4" DEEP FOR PROPER INSTALLATION. ALL M1 CANTILEVER PARASOLS SHIP WITH STAINLESS STEEL SECURITY STEM & BEAUTY COVER.

FOR USE ON EXISTING CONCRETE PAD		
		LIST PRICE EUR
MAXPLATE	INSTALLATION PROCESS DEPICTED ABOVE	

PRODUCT ANATOMY

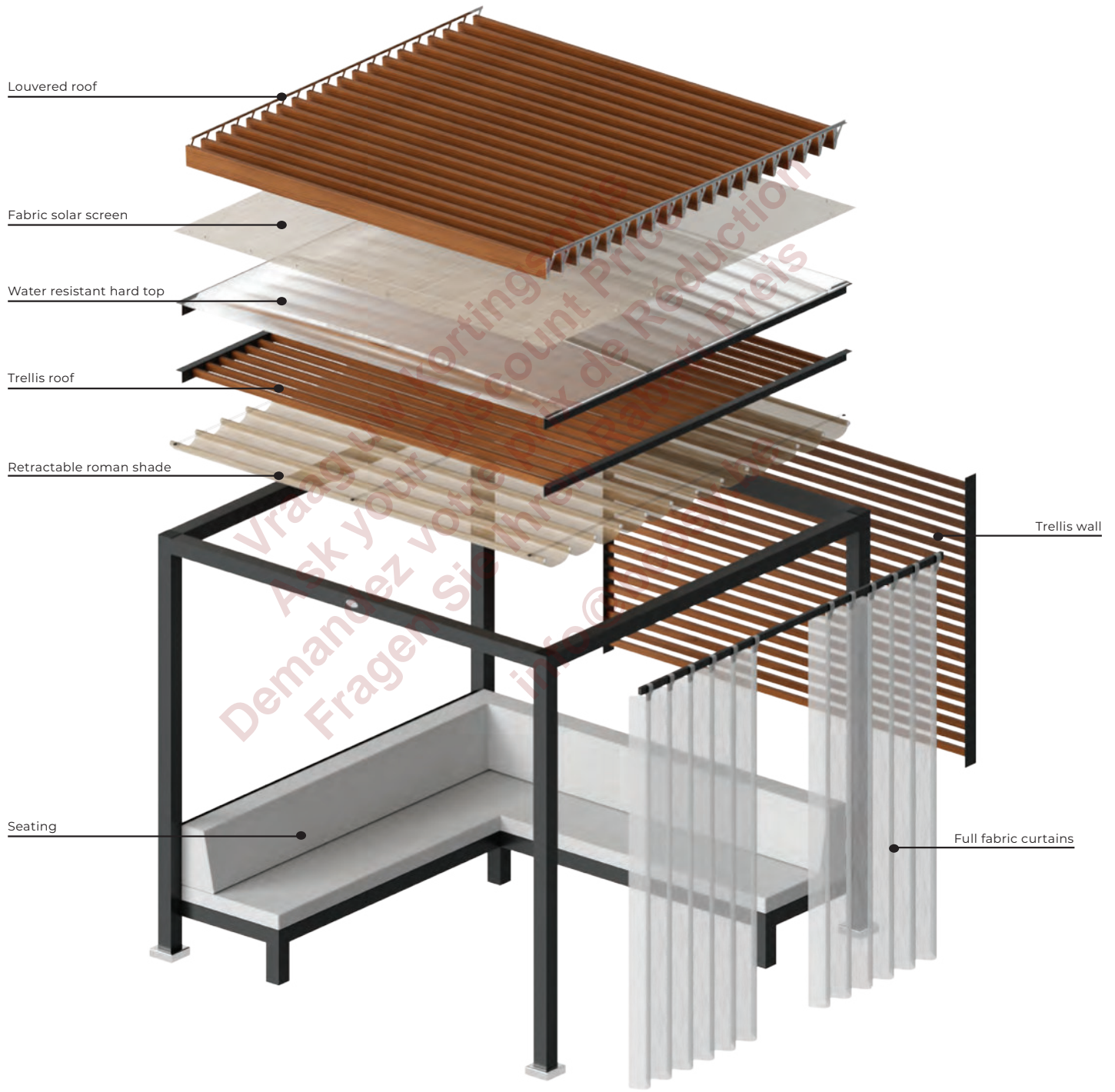

SOLANOX CABANA



PRODUCT OVERVIEW & PRICING

SOLANOX CABANA

Tuuci Solanox Cabana structures effortlessly transform any patio, poolside or outdoor landscape into open-air living rooms. The structure's sleek modular design is built to custom specifications; shape, size, finish, walls, seating and lighting options. The outdoors never felt more luxurious.

SOLANOX CABANA		FRAME FINISH		ROOF							SIDE WALL - PER SIDE			SEATING - LEVEL B			
		A		B							C			D			
 <p>LIST PRICE EUR INCLUDES CORNER COLUMNS & BEAMS</p> <p>POWDER COAT OPTIONS: SEE PAGE 102 FOR DETAILS</p> <p>PLANTATION ALUMA-TEAK™ OPTIONS: SEE PAGE 102 FOR DETAILS</p> <p>RETRACTABLE ROMAN SHADE SEE PAGE 102 FOR FABRIC OPTIONS) DO NOT SPECIFY WITH FAN MOUNT BEAM, HEATERS OR LOUVERED ROOF</p> <p>TRELLIS ROOF - POWDER COAT</p> <p>TRELLIS ROOF - PLANTATION ALUMA-TEAK™</p> <p>WATER RESISTANT HARD TOP ROOF (POLYCARBONATE) WITH SUPPORT TRELLIS</p> <p>FABRIC SOLAR SCREEN + TRELLIS ROOF</p> <p>AUTOMATED LOUVERED ROOF WITH TEMPERATURE SENSOR AND REMOTE - POWDER COAT. MUST USE 9X9 OR ICSM ANCHOR ON SINGLE AND ALL CONNECTED CABANAS</p> <p>AUTOMATED LOUVERED ROOF WITH TEMPERATURE SENSOR AND REMOTE - PLANTATION ALUMA-TEAK™ MUST USE 9X9 OR ICSM ANCHOR ON SINGLE AND ALL CONNECTED CABANAS</p>																	
SQUARE		A1	A2	B1	B2	B3	B4	B5	B6	B7	C1	C2	C3	D1	D2	D3	D4
EQC8.0SQ 8' / 2.45M	6375	INCL	1380	3360	4120	4465	5015	6155	21635	24300	3155	3570	1650	8230	13030	—	13030
EQC10.0SQ 10' / 3.0M	7545	INCL	1720	4045	4805	5150	6030	7375	23300	26630	3290	3700	1790	8920	13300	17825	—
EQC12.0SQ 12' / 3.65M	8710	INCL	2065	4120	5485	5835	6170	8320	26630	30620	3425	3845	1925	9600	13720	19205	—
RECTANGLE		A1	A2	B1	B2	B3	B4	B5	B6	B7	C1	C2	C3	D1	D2	D3	D4
EQC8X10RECT 8' X 10' / 2.45M X 3.0M	7065	INCL	1445	3360	4260	4595	5285	6555	21970	24930	3290	3975	1650	8920	13300	19205	—
EQC8X12RECT 8' X 12' / 2.45M X 3.65M	7545	INCL	1720	4045	4805	5150	6030	7240	22305	25330	3425	4120	1790	9600	13515	19205	—
EQC10X12RECT 10' X 12' / 3.0M X 3.65M	8025	INCL	2065	4120	5485	5835	6105	8190	23635	27295	3570	4260	1925	9600	13720	19205	—



B1 - Retractable Roman Shade



B2/B3 - Trellis Roof



B4 - Water Resistant Hard Top Roof



B5 - Solar Screen



B6 - Automated Louvered Roof

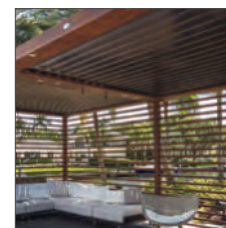
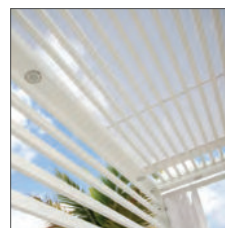
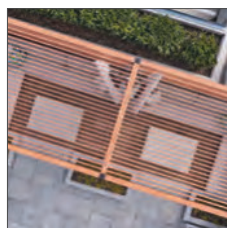

PRODUCT UPGRADES

ELECTRICAL OPTIONS

LIST PRICE EUR

OUTLET	BACK, LEFT VERTICAL COLUMN (AC OUTLET 120V/15AMPS)	895
OUTLET + USB	BACK, LEFT VERTICAL COLUMN (AC OUTLET 120V/15AMPS)	1330
LIGHTS	2 PER BEAM, INCLUDES OUTLET + USB ON BACK, LEFT VERTICAL COLUMN (LIGHTS 12V/4AMPS, AC OUTLET 120V/15AMPS)	6445
TV MOUNT	SPECIFY COLUMN, INCLUDES OUTLET (AC OUTLET 120V/15AMPS)	1720
FAN MOUNT	CENTER BEAM, FAN NOT INCLUDED. AVAILABLE WITH OPEN ROOF, TRELIS ROOF & WATER RESISTANT HARD TOP ROOF	2065
HEAT	2 HEATERS PER CABANA, LEFT AND RIGHT BEAMS, PLUG ON RIGHT BACK COLUMN (220V/15AMPS) AVAILABLE WITH WATER RESISTANT HARD TOP ROOF & AUTOMATED LOUVERED ROOF ONLY	5485

OUTLET



LIGHTS



TV MOUNT



FAN MOUNT

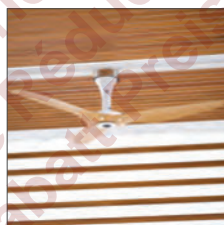

HEAT



AUTOMATED LOUVERED ROOF OPTIONAL ACCESSORIES

LIST PRICE EUR

RAIN SENSOR	SOMFY® ONDEIS WIREFREE RTS RAIN SENSOR DETECTS PRECIPITATION AND AUTOMATICALLY CLOSES THE LOUVERED ROOF. RAIN SENSOR MUST BE SELECTED AT THE TIME THE LOUVERED ROOF IS ORDERED AS INTERNAL MOUNTING BRACKET IS PART OF THE MANUFACTURING PROCESS. NOT AVAILABLE AS AN AFTER MARKET ACCESSORY. BATTERY INCLUDED.	995
WIND SENSOR	SOMFY® EOLIS RTS WIND SENSOR, 24V AUTOMATICALLY OPENS THE LOUVERED ROOF AT A PRE-SET WIND SPEED. WIND SENSOR MUST BE SELECTED AT THE TIME THE LOUVERED ROOF IS ORDERED AS INTERNAL WIRING INSTALLATION IS PART OF THE MANUFACTURING PROCESS. NOT AVAILABLE AS AN AFTER MARKET ACCESSORY. WIND SETTINGS RANGE FROM 6 TO 60 MPH / 10 TO 100 KM/H.	870
REMOTE	SOMFY® TELIS 4 RTS PATIO REMOTE, 5 CHANNEL REMOTE CONTROL TO OPERATE UP TO 5 INDEPENDENT LOUVERED ROOFS FROM THE SAME REMOTE. WATER AND SHOCK RESISTANT FOR OUTDOOR USE. WIRELESS RANGE UP TO 65 FEET / 20 M.	310

RAIN SENSOR



WIND SENSOR



REMOTE



BOLSTERS, THROW PILLOWS & SHEETS					LIST PRICE EUR	FABRIC		FABRIC UPGRADE	
						INCL	INCL	10%	20%
						SEE PAGE 133 FOR DETAILS		SEE PAGE 133 FOR DETAILS	
						LEVEL B	LEVEL C	LEVEL D	LEVEL E
MINI BOLSTER PILLOW	(SUGGESTED QTY 2)	15 X 46CM	INCL ZIPPER & OPTIONAL WELT	200	INCL	INCL	○	○	
SMALL THROW PILLOW	(SUGGESTED QTY 2)	41 X 41CM	INCL ZIPPER & OPTIONAL WELT	200	INCL	INCL	○	○	
MEDIUM THROW PILLOW	(SUGGESTED QTY 4)	56 X 56CM	INCL ZIPPER & OPTIONAL WELT	235	INCL	INCL	○	○	
LARGE THROW PILLOW	(SUGGESTED QTY 4)	66 X 66CM	INCL ZIPPER & OPTIONAL WELT	240	INCL	INCL	○	○	
BENCH	K600004	(1) BENCH CUSHION COVER	—	500	INCL	10%	○	○	
L BENCH	K600004	(2) L BENCH CUSHION COVERS	—	560 EACH	INCL	10%	○	○	
2.45M SQ MATTRESS (245 X 260CM)	K600004	FULL BED MATTRESS COVER	—	1700	INCL	10%	○	○	

RETRACTABLE ROMAN SHADE & SOLAR SCREEN FABRIC COLORS



ANCHORS

LIST PRICE EUR	1005
HIGH WIND USE STAINLESS STEEL SURFACE ANCHOR WITH LEVELING ANCHOR PLATE AND BEAUTY COVER EXISTING CONCRETE 1 PER COLUMN	

LIST PRICE EUR	830
HIGH WIND USE IN-GROUND SECURITY ANCHOR WITH LEVELING ANCHOR PLATE AND BEAUTY COVER NEW CONCRETE POUR 1 PER COLUMN	

FINISHES

Plantation Aluma-TEAK™

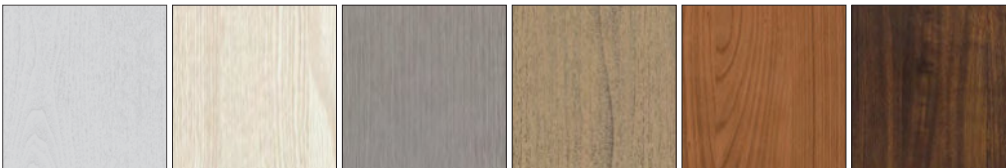

Aspen White Cypress Driftwood Weathered Natural Java

Powder Coat

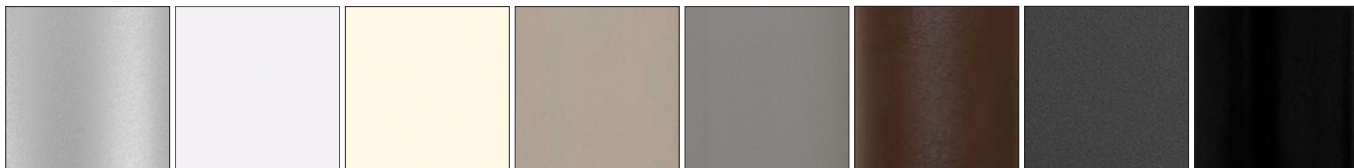

Silver Sand Glacier White Sandbar Oyster Night Fog Espresso Graphite Black Sea

PRODUCT ANATOMY

CABANAS



PRODUCT OVERVIEW & PRICING

ATLANTIS CABANA

Adding a dramatic sense of style to any setting has never been easier. The Atlantis Cabana is an impressive combination of Tuuci's distinctive style and customary utility. **Standard features include:** straight valance with braid binding & vector vent canopy. High wind stabilizers on 3.0m / 10.0' square and 2.45x3.65M / 8'x12' Rectangle.

ATLANTIS CABANA				STANDARD INCLUDED				ENHANCEMENT OPTIONS					
				FABRIC	PROFILE	CURTAINS	FINISH		1735	720	3720	4775	2485
				SEE PAGE 133 FOR DETAILS	VALANCE (STRAIGHT, SCALLOPED, CLASSIC OR MODERN ROMAN)	ACCENT CURTAINS	POLISHED TITANIUM	VINEYARD DURA-TEAK	FULL CURTAINS	CONTRASTING CURTAIN SIDE TRIM	SIDE AND BACK FABRIC WALLS WITH FULL FRONT CURTAIN	SIDE AND BACK FABRIC WALLS WITH WINDOWS AND FULL FRONT CURTAIN	BACK FABRIC WALL WITH FRONT AND SIDE FULL CURTAINS
SQUARE & RECTANGLE	EXTERIOR DIMENSION	INTERIOR DIMENSION	LIST PRICE EUR										
APOM8.0SQ	8.0' / 2.45M	7.3' / 2.2M	9755	INCL	INCL	INCL	INCL	INCL	○	○	○	○	○
APOM10.0SQ	10.0' / 3.0M	9.3' / 2.8M	11105	INCL	INCL	INCL	INCL	INCL	○	○	○	○	○
APOM8X12RECT	8.0' X 12.0' / 2.45M X 3.65M	7.3' X 11.1' / 2.2M X 3.4M	11545	INCL	INCL	INCL	INCL	INCL	○	○	○	○	○

GRAND PACIFIC CABANA

The ultimate in beauty and privacy with maximum durability. Topped with an oversized market profile, Vector Vent canopy and flanked with three optional tensioned structural fabric walls, the Grand Pacific offers a romantic retreat and spacious outdoor room. **Standard features include:** market cut profile with vector vent and high wind stabilizers.

GRAND PACIFIC CABANA				STANDARD INCLUDED				ENHANCEMENT OPTIONS					
				FABRIC	PROFILE	CURTAINS	FINISH		1735	720	3720	4775	2485
				SEE PAGE 133 FOR DETAILS	MARKET CUT PROFILE	ACCENT CURTAINS	POLISHED TITANIUM	FULL CURTAINS	CONTRASTING CURTAIN SIDE TRIM	SIDE AND BACK FABRIC WALLS WITH FULL FRONT CURTAIN	SIDE AND BACK FABRIC WALLS WITH WINDOWS AND FULL FRONT CURTAIN	BACK FABRIC WALL WITH FRONT AND SIDE FULL CURTAINS	
													LIST PRICE EUR
SQUARE	EXTERIOR DIMENSION	INTERIOR DIMENSION	LIST PRICE EUR										
GP12.0SQ	12.0' / 3.7M	9.3' / 2.8M	12865	INCL	INCL	INCL	INCL	○	○	○	○	○	

ST. TROPEZ CABANA

This pavilion is inspired by the seaside lifestyles of the Mediterranean coast. The St. Tropez Cabana features three fabric walls and a unique, height adjustable, retractable awning, as well as interior privacy drapes that are ideal for creating a secluded changing or storage area. **Standard features include:** straight valance with acrylic binding, fabric walls (3 sides), manual lift system with stainless steel security pin. Requires 5 deck mounts.

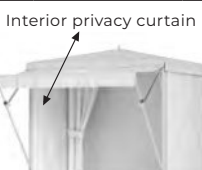
ST. TROPEZ CABANA				STANDARD INCLUDED				ENHANCEMENT OPTIONS		
				FABRIC	PROFILE	WALLS	FINISH		1735	905
				SEE PAGE 133 FOR DETAILS	VALANCE (STRAIGHT, SCALLOPED, CLASSIC OR MODERN ROMAN)	TENSIONED OUTER FABRIC WALLS 3-SIDES	POLISHED TITANIUM	TENSIONED INTERIOR FABRIC WALL	INTERIOR PRIVACY CURTAIN	
										LIST PRICE EUR
SQUARE	EXTERIOR DIMENSION	INTERIOR DIMENSION	LIST PRICE EUR							
STP10.0SQ	10' X 12.0' / 3M X 3.65M	7.1' X 9.5' / 2.2M X 2.9M	17030	INCL	INCL	INCL	INCL	○	○	

ABOVE GROUND SHADE ANCHORS OVERVIEW & PRICING

ALUMA-CRETE ROUND

ALUMINIUM, CONCRETE FILLED SHELL, FOUR HOLE VERSION WITH STAINLESS STEEL SECURITY SLEEVE.
TOLERANCES +/- 4.5 KG / 10 LBS

ALUMA-CRETE ROUND		LIST PRICE EUR	FINISH	SECURITY SLEEVE	FINISH UPGRADE	SECURITY SLEEVE FINISH UPGRADE
			MARINE SILVER (STANDARD) POWDER COAT OPTIONS: SEE BELOW	38.1MM / 1.5" SECURITY SLEEVE	PLANTATION ALUMA-TEAK OPTIONS: SEE BELOW	POWDER COAT OPTIONS ONLY: SEE BELOW. MARINE SILVER NOT AVAILABLE
ACF95	43 KG / 95 LBS. 61CM / 24.0" DIAMETER	465	INCL	INCL	145	45
ACF150	68 KG / 150 LBS. 71CM / 28.0" DIAMETER	525	INCL	INCL	145	45

ALUMA-CRETE ROUND - WITH LIFT HANDLES		LIST PRICE EUR	FINISH	SECURITY SLEEVE	FINISH UPGRADE	SECURITY SLEEVE FINISH UPGRADE
			MARINE SILVER (STANDARD) POWDER COAT OPTIONS: SEE BELOW	38.1MM / 1.5" SECURITY SLEEVE	PLANTATION ALUMA-TEAK OPTIONS: SEE BELOW	POWDER COAT OPTIONS ONLY: SEE BELOW. MARINE SILVER NOT AVAILABLE
ACF200	91 KG / 200 LBS. 76CM / 30.0" DIAMETER	820	INCL	INCL	145	45

CURTAIN/WALL OPTIONS

<p>ACCENT CURTAINS</p> 	<p>FULL CURTAINS</p> 	<p>SIDE AND BACK FABRIC WALLS WITH FULL FRONT CURTAIN</p> 	<p>SIDE AND BACK FABRIC WALLS WITH WINDOWS AND FULL FRONT CURTAIN</p> 	<p>BACK FABRIC WALL WITH FRONT AND SIDE FULL CURTAINS</p> 
--	--	---	--	---

FINISHES

Plantation Aluma-TEAK™

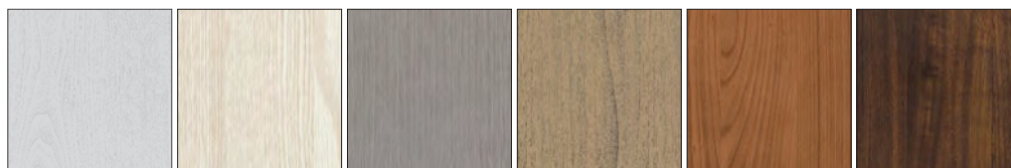

Aspen White Cypress Driftwood Weathered Natural Java

Powder Coat





Marine Silver Silver Sand Glacier White Sandbar Oyster Night Fog Espresso Graphite Black Sea

ABOVE GROUND SHADE ANCHORS OVERVIEW & PRICING

G-PLATE ANCHORS

GALVANIZED STEEL WITH STAINLESS STEEL SECURITY SLEEVE. G-PLATES AND COVERS HAVE FOUR HOLE PATTERN.
TOLERANCES +/- 4.5 KG / 10 LBS

G-PLATE ROUND		LIST PRICE EUR	FINISH	SECURITY SLEEVE	ANCHOR COVERS (FOR TOP G-PLATE ONLY)		SECURITY SLEEVE FINISH UPGRADE
						GALVANIZED STEEL	
GV24RND	34 KG / 75 LBS. 61CM / 24.0" DIAMETER	595	INCL	INCL			240
CV30RND	48 KG / 105 LBS. 76CM / 30.0" DIAMETER	765	INCL	INCL	240	285	45

G-PLATE ROUND - DOUBLE STACK		LIST PRICE EUR	FINISH	SECURITY SLEEVE	ANCHOR COVERS (FOR TOP G-PLATE ONLY)		SECURITY SLEEVE FINISH UPGRADE
						GALVANIZED STEEL	
GV18+30R	66 KG / 145 LBS. 76CM / 30.0" DIAMETER	960	INCL	INCL			-
CV24+30R	82 KG / 180 LBS. 76CM / 30.0" DIAMETER	1130	INCL	INCL	-	-	45
CV30+30R	95 KG / 210 LBS. 76CM / 30.0" DIAMETER	1300	INCL	INCL	240	285	45

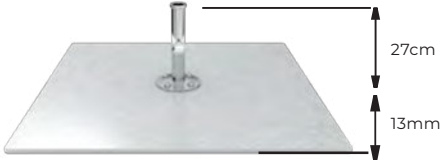
G-PLATE SQUARE		LIST PRICE EUR	FINISH	SECURITY SLEEVE	ANCHOR COVERS (FOR TOP G-PLATE ONLY)		SECURITY SLEEVE FINISH UPGRADE
						GALVANIZED STEEL	
GV24SQ	41 KG / 90 LBS. 61CM / 24.0" SQUARE	685	INCL	INCL			240
GV30SQ	64 KG / 135 LBS. 76CM / 30.0" SQUARE	955	INCL	INCL	365	445	45
GV24+24SQ	82 KG / 180 LBS. 61CM / 24.0" SQUARE	1145	INCL	INCL	240	285	45
GV36SQ	90 KG / 200 LBS. 90CM / 36.0" SQUARE	1255	INCL	INCL	365	445	45

IN GROUND SHADE ANCHORS OVERVIEW & PRICING

STAINLESS STEEL FLUSH MOUNT WITH CONCRETE CYLINDER

FOR SOFT SURFACES AND PAVERS. INCLUDES 61CM / 24" ALUMINUM EXTENSION SLEEVE FOR USE WITH A 38.1MM / 1.5" MAST. CONCRETE CYLINDER WEIGHS 50 KG / 110 LBS. TOLERANCES +/- 4.5 KG / 10 LBS

FOR USE IN NEW POUR CONCRETE, SOIL OR SAND		
		LIST PRICE EUR
SSFMC	INSTALLATION PROCESS DEPICTED ABOVE	

STAINLESS STEEL FLUSH MOUNT

FOR CONCRETE INSTALLATIONS: INCLUDES 3 DROP-IN ANCHOR BOLTS. 44.5MM / 1.75" DIAMETER STAINLESS STEEL FLUSH MOUNT. INCLUDES 61CM / 24" ALUMINUM EXTENSION SLEEVE FOR USE WITH A 38.1MM / 1.5" MAST.

FOR USE ON EXISTING CONCRETE PAD		
		LIST PRICE EUR
FLUSHMT	INSTALLATION PROCESS DEPICTED ABOVE	

SHADE ANCHORS ACCESSORIES & PRICING

STAINLESS STEEL SECURITY SLEEVE - DECK MOUNTS

FOR CONCRETE INSTALLATIONS: INCL. 4 DROP-IN ANCHOR BOLTS. FOUR HOLE PATTERN.

STAINLESS STEEL SECURITY SLEEVE - DECK MOUNTS				
			LIST PRICE EUR	
DECKMNT	38.1MM / 1.5" SECURITY SLEEVE			230
DECKMNT	38.1MM / 1.5" AUTO-CAM LOCK SECURITY SLEEVE			+115

PRODUCT ANATOMY

LOUNGES



PRODUCT OVERVIEW & PRICING

SOLANOX DOUBLE CHAISE LOUNGE

Tuuci's exclusive Solanox Double Chaise Lounge is luxury and durability in one package. Engineered with 10cm / 4" square Armor Wall aluminum extrusions, and finished with our range of powder-coat options or our exclusive Aluma-TEAK™ finish, this eye-popping piece is at home in any commercial or residential environment. **Standard features include:** adjustable back rest.

SOLANOX DOUBLE CHAISE LOUNGE			STANDARD INCLUDED		FINISH UPGRADE
			SEATING	FRAME FINISH	1550
			LIST PRICE EUR	SEE PAGE 133 FOR DETAILS	PLANTATION ALUMA-TEAK OPTIONS: SEE PAGE 102
				POWDER COAT OPTIONS: SEE PAGE 102	
SQUARE	LOUNGE DIMENSION	LIST PRICE EUR	LEVEL B		
EQX6.5SQ	6'7" X 6'7" / 2 X 2M		13000	INCL	INCL

MERCURY LOUNGE

Open air, covered with shade and filled with cushions and comfort, the Mercury Bed & Sun Lounge takes relaxation to a new level. Constructed with Tuuci's polished-titanium Armor-Wall™ aluminum frame and modular marine grade components, the Mercury features high-performance fabric cushions and bed coverings with sheer privacy curtains. **Standard features include:** open cell foam mattress, inside valance, base cushion with side and rear bolsters. Optional matching throw pillows available. See page 113.

MERCURY LOUNGE					STANDARD INCLUDED				
					FABRIC	PROFILE	CURTAINS	FINISH	
					LIST PRICE EUR	SEE PAGE 133 FOR DETAILS	MARKET CUT PROFILE	SHEER ACRYLIC PRIVACY CURTAINS	POLISHED TITANIUM
						LEVEL C			
RECTANGLE	VERSION	LOUNGE DIMENSION	TOP DIMENSION	LIST PRICE EUR					
MLS	MERCURY WITH SUNROOF	4' X 7.5' / 125 X 230CM	4' X 7.5' / 125 X 230CM		14615	INCL	—	INCL	INCL
MLC	MERCURY WITH CANOPY	4' X 7.5' / 125 X 230CM	7.25' X 13.5' / 220 X 410CM	17610	INCL	INCL	INCL	INCL	

CRESCENT LOUNGE

Enjoying the natural world elements has never been so relaxing. The Crescent Lounge is an oasis of comfort and style, riding on 100 square feet of plush cushions, throw pillows, drapery and full open-air shade coverage. **Standard features include:** sheer fabric curtains, open cell foam mattress, inside valance, and base cushion with two side bolsters. Optional matching throw pillows available. See page 113.

CRESCENT LOUNGE					STANDARD INCLUDED				
					FABRIC	PROFILE	CURTAINS	FINISH	
					LIST PRICE EUR	SEE PAGE 133 FOR DETAILS	FISHTAIL PROFILE WITH VECTOR VENT, INCL. CANOPY BINDING (MATCHING STANDARD, CONTRASTING OPTION)	SHEER ACRYLIC PRIVACY CURTAINS	POLISHED TITANIUM
						LEVEL C			
SQUARE	VERSION	LOUNGE DIMENSION	TOP DIMENSION	LIST PRICE EUR					
CL	CRESCENT WITH CANOPY	7' X 7' / 215 X 215CM	11' X 11' / 340 X 340CM		23730	INCL	INCL	INCL	INCL

PRODUCT OVERVIEW & PRICING

AIR LOUNGE + WAVE STAND

From sunrise to sunset Tuuci's Air Lounge hammock is the ultimate way to relax. Designed for tranquility, its unique beauty is matched only by its durable construction of expandable ultra comfort sun mesh fabric with UV stabilized sun dye and durable hardwood stretcher bars. Years of awe-inspiring relaxation await your arrival. **Standard features include:** hardwood stretcher bars, dry core tension cord, stainless steel grommets, ballistic nylon reinforcement webbing, ultra comfort sun mesh fabric with UV stabilized sun dye, stainless steel step grid security hooks.

AIR LOUNGE + WAVE STAND				STANDARD INCLUDED	
				WAVE STAND FINISH	AIR LOUNGE COLOR
				STAINLESS STEEL	NATURAL OR BLACK
LIST PRICE EUR					
WSS	WAVE STAND (INCL. SET OF 2 LINKS)	5.0' X 14.0' / 140 X 435CM	2600	INCL	—
AIRLOUNGE2	AIR LOUNGE	4.0' X 7.0' / 120 X 215CM	720	—	INCL
AIRLOUNGE LINKS	STAINLESS STEEL LINKS (SET OF 2)	1.0" X 8.0" / 25 X 200MM	80	INCL	—
AIRLOUNGE STRAPS	SUSPENSION TRAPS FOR TREES/POSTS	1.5" X 92.0" / 38.1MM X 230CM	90	INCL	—

PRODUCT UPGRADES

ACCESSORIES

LIST PRICE EUR

FAN MOUNT	HARDWARE TO HANG FAN FROM PAVILION STRUCTURE. TO BE USED WITH FANS UP TO 14KG / 28LBS AND 115CM / 48" DIAMETER (FAN NOT INCLUDED). INCLUDES JUNCTION BOX.	500
TV MOUNT	HARDWARE TO SECURE FLAT SCREEN TV UP TO 102CM / 40", UP TO 18KG / 50LBS (TV NOT INCLUDED). INCLUDES JUNCTION BOX. COMES STANDARD ON BACK, LEFT CORNER VERTICAL POST UNLESS OTHERWISE SPECIFIED.	970
JUNCTION BOX	ELECTRICAL OUTLET PLUS WIRE FOR CORNER POST 120V, 15AMP, 1 PHASE, GFCI RECEPTACLE NEMA 5-15R. OUTDOOR RATED ENCLOSURE AND WATERPROOF. LOCATED AT BACK, LEFT, CORNER VERTICAL POST UNLESS OTHERWISE SPECIFIED.	375



FAN MOUNT



TV MOUNT



JUNCTION BOX

BOLSTERS, THROW PILLOWS, SHEETS & MATTRESSES				LIST PRICE EUR	FABRIC		FABRIC UPGRADE	
					INCL	INCL	10%	20%
				SEE PAGE 133 FOR DETAILS	SEE PAGE 133 FOR DETAILS			
					LEVEL B	LEVEL C	LEVEL D	LEVEL E
MINI BOLSTER PILLOW	(SUGGESTED QTY 2)	15 X 46CM	INCL ZIPPER & OPTIONAL WELT	200	INCL	—	—	—
SMALL THROW PILLOW	(SUGGESTED QTY 2)	41 X 41CM	INCL ZIPPER & OPTIONAL WELT	200	INCL	INCL	o	o
MEDIUM THROW PILLOW	(SUGGESTED QTY 4)	56 X 56CM	INCL ZIPPER & OPTIONAL WELT	235	INCL	INCL	o	o
LARGE THROW PILLOW	(SUGGESTED QTY 4)	66 X 66CM	INCL ZIPPER & OPTIONAL WELT	240	INCL	INCL	o	o
FITTED SHEET	MERCURY			625	INCL	INCL	—	—
FITTED SHEET	CRESCENT			870	INCL	INCL	—	—
K600010 BOLSTERS	REAR BOLSTERS	CRESCENT		560	INCL	—	—	—
	SIDE BOLSTERS	CRESCENT		435	INCL	—	—	—
K600001	MATTRESS REPLACEMENT	MERCURY	OPEN CELL FOAM	3195	—	—	—	—
K600002	MATTRESS REPLACEMENT	CRESCENT	OPEN CELL FOAM	5145	—	—	—	—
K600005	MATTRESS REPLACEMENT	SOLANOX DCL	OPEN CELL FOAM	3405	—	—	—	—

PRODUCT ANATOMY

HIGHLAND PLANTERS



Powder Coat

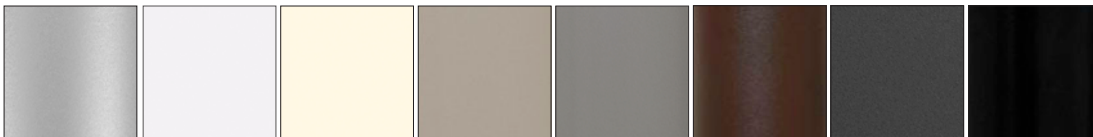

Silver Sand Glacier White Sandbar Oyster Night Fog Espresso Graphite Black Sea

Plantation Aluma-TEAK™



Aspen White Cypress Driftwood Weathered Natural Java

PRODUCT OVERVIEW & PRICING

HIGHLAND PLANTER

Reminiscent of the mixed materials from sailing yachts and today's luxurious furniture designs, the Highland Garden Planter is a refined version of timelessness, featuring thin ridges that provide an elevated accent to the wider channels. Enhance any outdoor aesthetic with the ability to select a premium Plantation Aluma-TEAK wood finish or powder coat on the channels combined with a powder coat or flagship polished titanium finish on the ridge.

HIGHLAND PLANTER		STANDARD INCLUDED					FINISH	SCREEN OPTION			LIGHT POST (LIGHTS NOT INCLUDED)		LINER	MOBILITY	ASSEMBLY	
		FINISH		LINER	MOBILITY			SIDE CHANNEL AND CORNER CHANNEL FINISH: PLANTATION ALUMA-TEAK™	TRELLIS SCREEN: POWDER COAT	TRELLIS SCREEN: POWDER COAT FRAME AND PLANTATION ALUMA-TEAK™ TRELLIS	ESPALIER: POWDER COAT FINISH	FINISH				
LOW	D x W x H	LIST PRICE EUR	SIDE CHANNEL AND CORNER CHANNEL FINISH: POWDER COAT		CORNER RIDGE AND SIDE RIDGE FINISH: POLISHED TITANIUM OR POWDER COAT	SOFT LINER (DOES NOT RETAIN WATER)	STATIONARY ADJUSTABLE GLIDES					SIDE CHANNEL AND CORNER CHANNEL FINISH: PLANTATION ALUMA-TEAK™	TRELLIS SCREEN: POWDER COAT	TRELLIS SCREEN: POWDER COAT FRAME AND PLANTATION ALUMA-TEAK™ TRELLIS	ESPALIER: POWDER COAT FINISH	POWDER COAT
HGP14X18LOW	14" x 18" x 18" 36 x 46 x 46CM	975	INCL	INCL	INCL	INCL	225	—	—	—	325	435	195	135	100	
HGP14X36LOW	14" x 36" x 18" 36 x 92 x 46CM	1150	INCL	INCL	INCL	INCL	250	835	975	915	325	435	235	135	100	
HGP36X36LOW	36" x 36" x 18" 92 x 92 x 46CM	2125	INCL	INCL	INCL	INCL	375	—	—	—	325	435	—	190	130	
HGP14X72LOW	14" x 72" x 18" 36 x 183 x 46CM	1675	INCL	INCL	INCL	INCL	300	1435	1651	—	325	435	395	190	130	
TALL	D x W x H															
HGP14X18TALL	14" x 18" x 30" 36 x 46 x 76CM	1350	INCL	INCL	INCL	INCL	350	—	—	—	325	435	195	135	160	
HGP14X36TALL	14" x 36" x 30" 36 x 92 x 76CM	1550	INCL	INCL	INCL	INCL	425	—	—	—	325	435	235	190	160	
HGP14X72TALL	14" x 72" x 30" 36 x 183 x 76CM	2050	INCL	INCL	INCL	INCL	525	—	—	—	325	435	395	190	160	

ENHANCEMENT OPTIONS

TRELLIS SCREEN



ESPALIER SCREEN



LIGHT POST



MOBILITY CASTERS (NON-LOCKING)



PRODUCT ANATOMY

MAINLAND PLANTERS

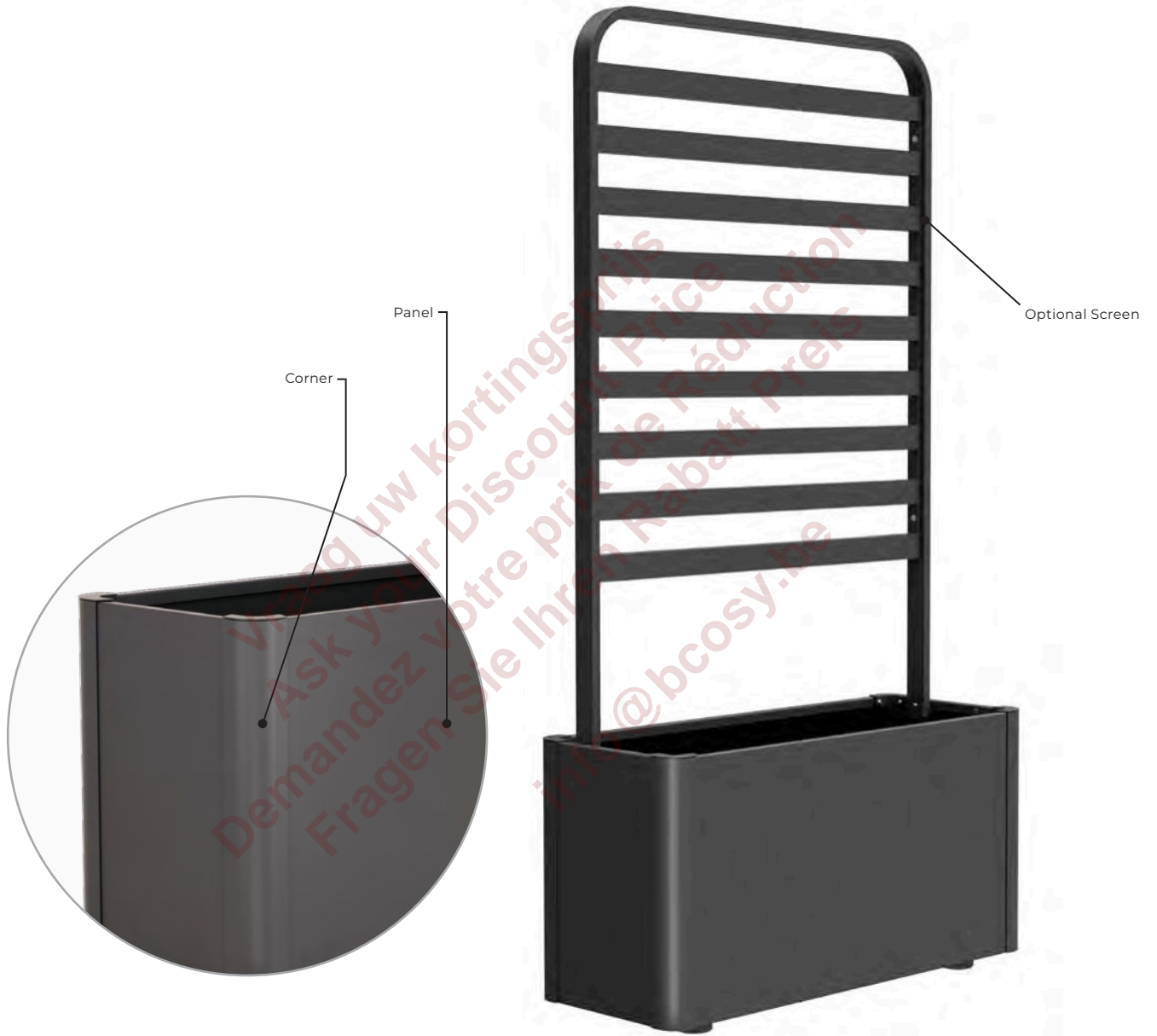

Powder Coat

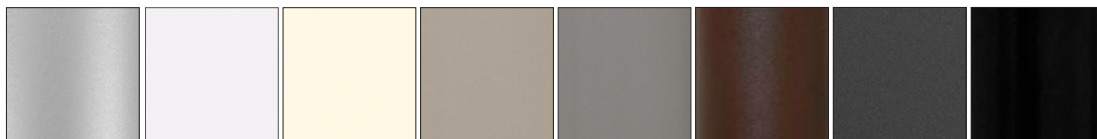

Silver Sand Glacier White Sandbar Oyster Night Fog Espresso Graphite Black Sea

PRODUCT OVERVIEW & PRICING

MAINLAND PLANTER

The simple and monochromatic design of the Mainland Garden Planter offers a nod to contemporary design roots. Available in eight powder coat finishes, it can be comfortably situated as a complementary architectural feature in a classic setting.

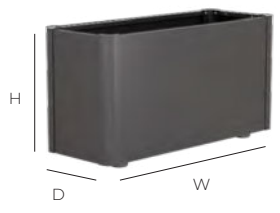
MAINLAND PLANTER		LIST PRICE EUR	STANDARD INCLUDED			SCREEN OPTION			LIGHT POST (LIGHTS NOT INCLUDED)		LINER	MOBILITY	ASSEMBLY
			FINISH	LINER	MOBILITY	TRELLIS SCREEN	TRELLIS SCREEN AND ESPALIER	ESPALIER	FINISH				
			POWDER COAT	SOFT LINER (DOES NOT RETAIN WATER)	STATIONARY ADJUSTABLE GLIDES	TRELLIS SCREEN: POWDER COAT	TRELLIS SCREEN: POWDER COAT FRAME AND PLANTATION ALUMA-TEAK™ TRELLIS	ESPALIER: POWDER COAT FINISH	POWDER COAT	PLANTATION ALUMA-TEAK™	HARD LINER FOR LOOSE SOIL (RETAINS WATER)	CASTERS (NON-LOCKING)	FULL ASSEMBLY AT TUUCI. ADDITIONAL FREIGHT MAY APPLY
LOW	D x W x H												
MGP14X18LOW	14" x 18" x 18" 36 x 46 x 46CM	685	INCL	INCL	INCL	—	—	—	325	435	195	135	65
MGP14X36LOW	14" x 36" x 18" 36 x 92 x 46CM	775	INCL	INCL	INCL	835	975	915	325	435	235	135	65
MGP36X36LOW	36" x 36" x 18" 92 x 92 x 46CM	1350	INCL	INCL	INCL	—	—	—	325	435	—	135	120
TALL	D x W x H												
MGP14X18TALL	14" x 18" x 30" 36 x 46 x 76CM	1050	INCL	INCL	INCL	—	—	—	325	435	195	125	120
MGP14X36TALL	14" x 36" x 30" 36 x 92 x 76CM	1275	INCL	INCL	INCL	—	—	—	325	435	235	125	120

ENHANCEMENT OPTIONS

LIGHT POST

TRELLIS SCREEN



ESPALIER SCREEN



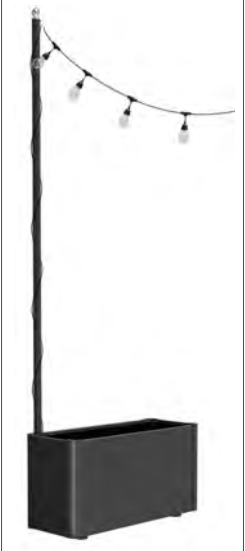

MOBILITY CASTERS (NON-LOCKING)



PRODUCT ANATOMY

FREESTANDING TRELLIS SCREEN



Powder Coat

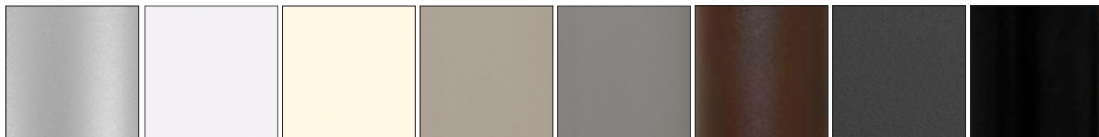

Silver Sand

Glacier White

Sandbar

Oyster

Night Fog

Espresso

Graphite

Black Sea

Plantation Aluma-TEAK™



Aspen White

Cypress

Driftwood

Weathered

Natural

Java

PRODUCT OVERVIEW & PRICING

FREESTANDING TRELLIS SCREEN

Tuuci's stunning Freestanding Trellis Screen is a multi-functional piece that provides privacy and adds an element of beauty to any exterior setting. Its versatile design allows for various applications, whether you're looking to section off an outdoor dining area, create a secluded spot, or add architectural interest to your space. Available in eight powder coat finishes on the frame and fourteen powder coat and Plantation Aluma-TEAK finishes on the trellis.





FREESTANDING TRELLIS SCREEN		LIST PRICE EUR	STANDARD INCLUDED		FINISH UPGRADE
			FINISH	ANCHOR	
 <p>D x W x H</p>			POWDER COAT	STANDS	POWDER COAT FRAME AND PLANTATION ALUMA-TEAK™ TRELLIS
FGS60X37	22" x 37" x 60" 152 x 94 x 56CM	1050	INCL	INCL	200
FGS60X74	22" x 74" x 60" 152 x 188 x 56CM	1750	INCL	INCL	325





FREESTANDING LIGHT POST





Brighten up your outdoor oasis with our innovative Freestanding Light Pole, designed to complement your planters and elevate the ambiance of your exterior living space. Tailored to perfection, this lighting solution is more than just functional; it's a statement piece that harmonizes beautifully with nature and architecture. Select a premium Plantation Aluma-TEAK wood finish or powder coat finish on the light pole.





FREESTANDING LIGHT POST		LIST PRICE EUR	STANDARD INCLUDED		FINISH UPGRADE
			FINISH	ANCHOR	
 <p>LIGHTS NOT INCLUDED</p>			POLISHED TITANIUM OR POWDER COAT	G-PLATE (46CM / 18" DIAMETER, 13CM / 0.5" HEIGHT) GALVANIZED STEEL FINISH	PLANTATION ALUMA-TEAK™ (LIGHT POST ONLY)
GLP108X18	WITH G-PLATE ANCHOR 18KG / 40LB AND 275CM / 108" TALL	705	INCL	INCL	195

SHADE RECOVERS (CANOPY ONLY)

MEGA MAX CENTER POST		FABRIC	VENT	PROFILE		ENHANCEMENT OPTIONS		
		INCL	INCL	INCL	2445	990	1035	2340
	LIST PRICE EUR	MARINE MXT 9700 SERIES SEE PAGE 133 FOR ADDITIONAL OPTIONS	SINGLE WIND VENT (MATCHING STANDARD, CONTRASTING OPTION)	MARKET CUT PROFILE	VALANCE (STRAIGHT, SCALLOPED, CLASSIC OR MODERN ROMAN)	CONTRASTING POCKETS	CONTRASTING BINDING ON CANOPY AND VENT	25CM ACCENT BORDER ON CANOPY
SQUARE		LEVEL C						
490CM / 16.0'	5995	INCL	INCL	INCL	o	o	o	o
550CM / 18.0'	6242	INCL	INCL	INCL	o	o	o	o
600CM / 20.0'	6650	INCL	INCL	INCL	o	o	o	o
730CM / 24.0'	6995	INCL	INCL	INCL	o	o	o	o
ROUND		LEVEL C						
490CM / 16.0'	5995	INCL	INCL	INCL	o	o	o	o
600CM / 20.0'	6650	INCL	INCL	INCL	o	o	o	o
730CM / 24.0'	6995	INCL	INCL	INCL	o	o	o	o
RECTANGLE		LEVEL C						
425 x 600CM / 14' x 20.0'	5995	INCL	INCL	INCL	o	o	o	o
490 x 730CM / 16' x 24.0'	6650	INCL	INCL	INCL	o	o	o	o
550 x 730CM / 18' x 24.0'	6995	INCL	INCL	INCL	o	o	o	o

MAX CENTER POST		FABRIC	VENT	PROFILE		ENHANCEMENT OPTIONS			
		INCL	INCL	INCL	680	280	285	280	680
	LIST PRICE EUR	ALL MXT SERIES SEE PAGE 133 FOR ADDITIONAL OPTIONS	SINGLE WIND VENT (MATCHING STANDARD, CONTRASTING OPTION)	MARKET CUT PROFILE	VALANCE (STRAIGHT, SCALLOPED, CLASSIC OR MODERN ROMAN)	FISHTAIL PROFILE, INCLUDES CANOPY BINDING (MATCHING STANDARD, CONTRASTING OPTION)	CONTRASTING POCKETS	CONTRASTING BINDING ON CANOPY AND VENT	15CM ACCENT BORDER ON CANOPY (25CM / 10" ON FI)
SQUARE		LEVEL C							
245 - 305CM / 8' - 10'	1970	INCL	INCL	INCL	o	—	o	o	o
365 - 425CM / 12' - 14'	2460	INCL	INCL	INCL	o	—	o	o	o
490CM / 16'	3105	INCL	INCL	INCL	o	—	o	o	o
400CM / 13' (F-1)	4500	INCL	INCL	INCL	o	—	o	o	o
OCTAGON		LEVEL C							
275 - 425CM / 9' - 14'	1970	INCL	INCL	INCL	o	o	o	o	o
450 - 520CM / 15' - 17'	2460	INCL	INCL	INCL	o	o	o	o	o
550CM / 18'	3105	INCL	INCL	INCL	o	o	o	o	o
550CM / 18' (F-1)	4905	INCL	INCL	INCL	o	o	o	o	o
RECTANGLE		LEVEL C							
245 x 365CM / 8' x 12'	2460	INCL	INCL	INCL	o	—	o	o	o
305 x 425CM / 10' x 14'	2780	INCL	INCL	INCL	o	—	o	o	o
365 x 490CM / 12' x 16'	3105	INCL	INCL	INCL	o	—	o	o	o

M1 CENTER POST		FABRIC	VENT		PROFILE			ENHANCEMENT OPTIONS		
		INCL	INCL	115	INCL	250	115	115	115	250
	LIST PRICE EUR	ALL MXT SERIES. SEE PAGE 133 FOR MORE DETAILS	SINGLE WIND VENT (MATCHING STANDARD, CONTRASTING OPTION)	DOUBLE WIND VENT	MARKET CUT PROFILE	VALANCE (STRAIGHT, SCALLOPED, CLASSIC OR MODERN ROMAN)	FISHTAIL PROFILE (OFFERED ON MANTA, ZERO HORIZON AND CRESCENT) INCLUDES CANOPY BINDING (MATCHING STANDARD, CONTRASTING OPTION)	CONTRASTING POCKETS	CONTRASTING BINDING ON CANOPY AND VENT	15CM ACCENT BORDER ON CANOPY
SQUARE		LEVEL A, B & C								
135 - 165CM / 4.5' - 5.5'	755	INCL	INCL	—	INCL	○	—	○	○	○
200 - 245CM / 6.5' - 8.0'	910	INCL	INCL	—	INCL	○	—	○	○	○
260 - 305CM / 8.5' - 10'	1510	INCL	INCL	—	INCL	○	—	○	○	○
OCTAGON		LEVEL A, B & C								
150 - 225CM / 5' - 7.5'	1040	INCL	INCL	○	INCL	○	○	○	○	○
245 - 320CM / 8' - 10.5'	1120	INCL	INCL	○	INCL	○	○	○	○	○
340 - 425CM / 11' - 14'	1510	INCL	INCL	○	INCL	○	○	○	○	○
HEXAGON		LEVEL A, B & C								
165 - 215CM / 5.5' - 7'	910	INCL	INCL	○	INCL	○	○	○	○	○
260 - 305CM / 8.5' - 10.0'	1030	INCL	INCL	○	INCL	○	○	○	○	○
340 - 365CM / 11' - 12'	1430	INCL	INCL	○	INCL	○	○	○	○	○
OVAL & RECTANGLE		LEVEL A, B & C								
150x245 - 180x275CM / 5' x 8' - 6' x 9'	1245	INCL	INCL	—	INCL	○	—	○	○	○
275 x 340CM / 9' x 11'	1350	INCL	INCL	—	INCL	○	—	○	○	○
245 x 365CM / 8' x 12'	1500	INCL	INCL	—	INCL	○	—	○	○	○

MAX & M1 CANTILEVERS		FABRIC	VENT	PROFILE			ENHANCEMENT OPTIONS		
		INCL	INCL	INCL	995	470	285	470	995
	LIST PRICE EUR	ALL MXT SERIES. SEE PAGE 133 FOR ADDITIONAL OPTIONS	SINGLE WIND VENT (MATCHING STANDARD, CONTRASTING OPTION)	MARKET CUT PROFILE	VALANCE (STRAIGHT, SCALLOPED, CLASSIC OR MODERN ROMAN)	FISHTAIL PROFILE, INCLUDES CANOPY BINDING (MATCHING STANDARD, CONTRASTING OPTION)	CONTRASTING POCKETS	CONTRASTING BINDING ON CANOPY AND VENT	15CM ACCENT BORDER ON CANOPY
SQUARE		LEVEL C							
245CM / 8'	2050	INCL	INCL	INCL	○	—	○	○	○
305 - 365CM / 10' - 12'	2460	INCL	INCL	INCL	○	—	○	○	○
400CM / 13'	2990	INCL	INCL	INCL	○	—	○	○	○
OCTAGON		LEVEL C							
275CM / 9'	2050	INCL	INCL	INCL	○	○	○	○	○
340CM / 11'	2460	INCL	INCL	INCL	○	○	○	○	○
400CM / 13'	2995	INCL	INCL	INCL	○	○	○	○	○
RECTANGLE		LEVEL C							
245 x 365CM / 8' x 12'	2050	INCL	INCL	INCL	○	—	○	○	○
305 x 425CM / 10' x 14'	2730	INCL	INCL	INCL	○	—	○	○	○



Note: dual cantilevers require 2 recoverers per cantilever.

SHADE RECOVERS

STINGRAY		FABRIC		
		INCL	10%	20%
	LIST PRICE EUR	SEE PAGE 133 FOR ADDITIONAL OPTIONS AND PRICING		
STINGRAY		LEVEL C	LEVEL D	LEVEL E
215 x 305CM / 7.0' x 10.0'		INCL	○	○
275 x 400CM / 9.0' x 13.0'		INCL	○	○

	SQUARE AND RECTANGLE	LIST PRICE EUR	FABRIC
	FULL FABRIC CURTAINS (PER SIDE)	1610	SEE PAGE 133 FOR DETAILS
	RETRACTABLE ROMAN SHADE	2660	SEE PAGE 102 FOR DETAILS
	FABRIC SOLAR SCREEN	1985	SEE PAGE 102 FOR DETAILS

CABANAS		FABRIC	ENHANCEMENT OPTIONS			
		INCL	INCL	720	1025	
	LIST PRICE EUR	SEE PAGE 133 FOR DETAILS	VALANCE (STRAIGHT, SCALLOPED, CLASSIC OR MODERN ROMAN)	SIDE TRIM ON CURTAINS	WINDOWS ON FABRIC WALLS	
SQUARE AND RECTANGLE (ALL CABANA SIZES)		LEVEL C				
CANOPY RECOVER		2475	INCL	INCL	○	○
ACCENT CURTAINS		2080	INCL	INCL	○	○
FULL CURTAINS		3530	INCL	INCL	○	○
SIDE AND BACK FABRIC WALLS AND FULL FRONT CURTAIN		4240	INCL	INCL	○	○
BACK FABRIC WALL WITH FULL FRONT AND SIDE CURTAINS		3770	INCL	INCL	○	○

MERCURY LOUNGE			FABRIC	CRESCENT LOUNGE			FABRIC		
			INCL				INCL		
	LIST PRICE EUR	SEE PAGE 133 FOR DETAILS			LIST PRICE EUR	SEE PAGE 133 FOR DETAILS			
RECTANGLE			LEVEL C	RECTANGLE			LEVEL C		
TOP CANOPY WITH VECTOR VENT			2200	INCL	CANOPY			2755	INCL
RETRACTABLE SUNROOF AND SIDE CURTAINS			1065	INCL	SHEER CURTAINS			1065	INCL
SHEER CURTAINS			1065	INCL					

HIGH PERFORMANCE TEXTILES

NAUTICALLY DESIGNED FOR EXTREME ENVIRONMENTS

Tuuci's high performance exterior textiles are designed to endure nature's most extreme environments. This selection offers a range of dynamic colors, textures, and patterns, meticulously crafted in a variety of grades to enhance your outdoor shade experience and inspire you to live your best life outdoors.

PREMIER PXT SERIES

Premier PXT 10000

The most durable and highest performing textile for continued extreme exposure while offering excellent water repellency and superior tensile strength. It is a standard canopy option for the Ocean Master MAX F-1.

Premier PXT 10000-92

This series presents the unique balance of extreme strength and open weave construction, making it ideal for high wind applications where 100% shade and water resistance isn't required. This series offers 4% open weave ratio. It is a standard canopy option for the Ocean Master MAX F-1 and is recommended for the Stingray.

Premier PXT 10000-86

This series presents the unique balance of extreme strength and open weave construction, making it ideal for high wind applications where 100% shade and water resistance isn't required. This series offers 14% open weave ratio. It is a standard canopy option for the Ocean Master MAX F-1 and is recommended for the Stingray.

MARINE MXT SERIES

Marine MXT 9000-9600

Perfect for commercial and residential use in both extreme and moderate environments. This versatile acrylic fabric series offers the greatest selection of colors, the longest warranty, and is available on most products. *Flat binding required with fishtail profile. Braid binding required with valance.*

Marine MXT 9800

This two-ply polyester fabric with resin coating comes standard with a two-toned canopy, where the underside is white and the colored resin coating is on the top. Commonly used on the Ocean Master M1 Manta.

Marine MXT 9700

The polyester construction of the Marine MXT 9700 Series maintains a unique balance of strength to weight ratio and has been specifically selected for use with the Ocean Master MEGA MAX but is available on many other collections too.

COMFORT CXT SERIES

Comfort CXT 8000

This acrylic fabric is ideal for smaller parasols where the strength of marine grade fabric is not required. Also, this is the preferred option for cabana bench upholstery.

LIGHT LXT SERIES

Light LXT 7700

A lighter alternative to the MXT 9700 Series, the woven polyester construction is ideal for smaller parasols.

FABRIC LEVEL DEFINITION

VISIT TUUCI.COM/FABRICS TO VIEW ALL FABRIC SWATCHES

		premium MEGA MAX center post	premium MAX center post	premium MAX F-1 center post	premium MAX F-1 25cm accent border and accent cap	premium MAX cantilever	premium MAX stingray	premium M1 center post	premium M1 cantilever	essential M1 center post	essential M1 cantilever	cabanas and lounges: canopies and curtains	cabanas and lounges: beds, cushions and pillows	cover bags
Level B	Comfort CXT 8000 Series	—	—	—	—	—	—	—	—	INCL	INCL	INCL	INCL	INCL
	Light LXT 7700 Series	—	—	—	—	—	—	—	—	INCL	INCL	—	—	INCL
Level C	Marine MXT 9000 - 9600 Series	—	INCL	—	INCL	INCL	INCL	INCL	INCL	+10%	+10%	INCL	INCL	INCL
	Marine MXT 9800 Series	—	INCL	—	INCL	INCL	INCL	INCL	INCL	+10%	+10%	INCL	—	INCL
	Marine MXT 9700 Series	INCL	INCL	—	INCL	INCL	INCL	INCL	INCL	+10%	+10%	INCL	INCL	INCL
Level E	Premier PXT 10000 Series	—	+20%	INCL	INCL	+20%	+20%	+20%	+20%	+30%	+30%	+20%	—	—
	Premier PXT 10000-92 Series	—	+20%	INCL	INCL	+20%	+20%	+20%	+20%	+30%	+30%	+20%	—	—
	Premier PXT 10000-86 Series	—	+20%	INCL	INCL	+20%	+20%	+20%	+20%	+30%	+30%	+20%	—	—

ALTERNATE FABRIC OPTIONS

Tuuci is pleased to offer this comprehensive selection of High Performance Textiles to enhance the outdoor shade experience. Should there be a desire to specify a fabric that is not offered within the Tuuci Textiles offering, Tuuci can assist with procurement of fabrics for an additional net fee of €175 per fabric per order in addition to any fabric series upcharges.

If COM fabric is desired, a 25x25cm sample must be provided to your Tuuci Account Management Team for testing. Once approved for Tuuci use, ship the required COM meters to TUUCI with the corresponding Sales Order number tagged on the shipment.

SHIP TO: TUUCI Europe B.v.

Attn: COM FABRIC FOR (BILL TO NAME / SALES ORDER NUMBER)

De Nedervonder 17

5061 JP Oisterwijk

The Netherlands

HEATHERS & TEXTURES

Sophisticated textures add depth to outdoor projects.

No flat binding

No braid binding

Swatches shown in MXT



Sugar
MXT 9097



Fossil
MXT 9083



Sand
MXT 9093



Alabaster
MXT 9080



Pumice
MXT 9091



Nantucket Dune
MXT 9088



Mojave
MXT 9086



Moraine
MXT 9087



Stone
MXT 9096



Shale Rib
MXT 9095



Shadow
MXT 9094



Pewter Rib
MXT 9090



Stingray
MXT 9050



Charcoal Rib
MXT 9082

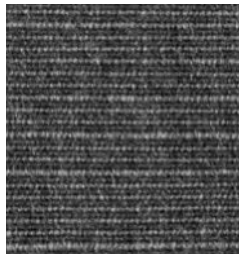

Ash Gray
MXT 9081



Onyx
MXT 9089



Glacier
MXT 9084

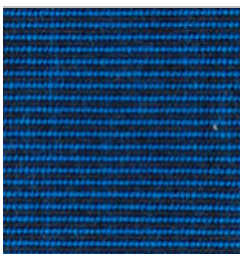

Royal Blue Rib
MXT 9092



Woodland
MXT 9098
CXT 8098



Hemlock Rib
MXT 9085

LAND & BEACH

These timeless neutrals in warm and cool shades integrate into any natural environment.

No flat binding

No braid binding

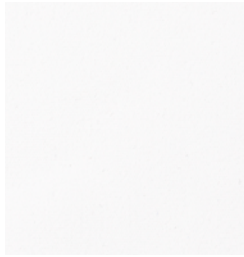

Snow

MXT 9105
CXT 8105

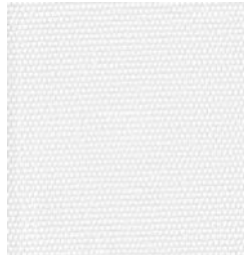

Natural

MXT 9003
CXT 8003



Scallop

MXT 9004



Malt

MXT 9102



Eggshell

MXT 9101

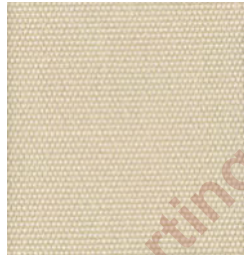

Crème

MXT 9100



Scone

MXT 9104



Sahara

MXT 9051



Beeswax

MXT 9099
CXT 8099



Ecru

MXT 9005



Thunder

MXT 9107



Truffle

MXT 9010
CXT 8010



Platinum

MXT 9007



Pearl

MXT 9103



Dolphin

MXT 9008

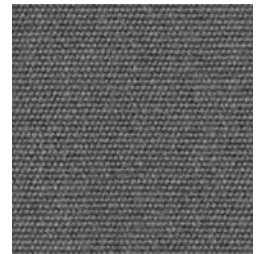

Anchor Gray

MXT 9009
CXT 8009



Cocoa Bean

MXT 9045
CXT 8045



Espresso

MXT 9046

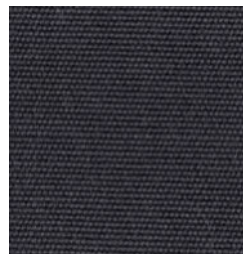

Tempest

MXT 9106



Black

MXT 9006
CXT 8006

SEA & SKY

Soothing greens and blues invoke calming waters and tranquil horizons.

No flat binding No braid binding

Swatches shown in MXT



Lichen
MXT 9113



Sprout
MXT 9299



Sage
MXT 9041

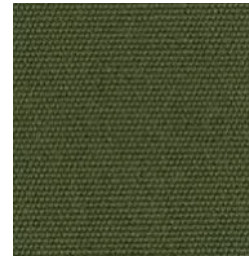

Moss
MXT 9296

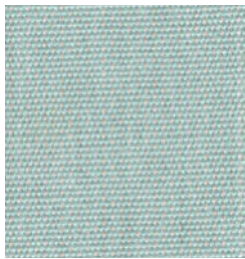

Sea Mist
MXT 9298



Turks
MXT 9015
CXT 8015



Curacao
MXT 9040



Bahama
MXT 9108



Heaven
MXT 9112

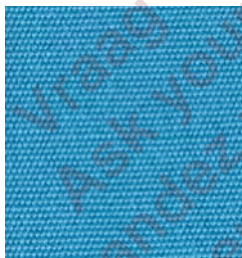

Harbour
MXT 9111

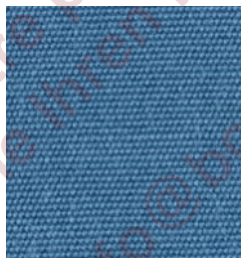

Cerulean
MXT 9109
CXT 8109

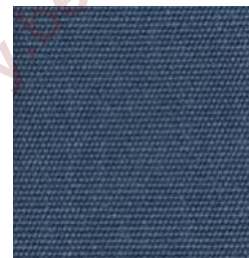

Blue Stone
MXT 9011
CXT 8011



French Lilac
MXT 9110



Portofino
MXT 9043
CXT 8043

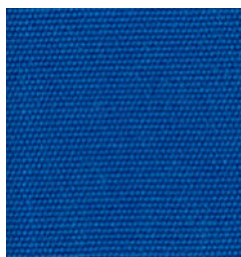

Regatta Blue
MXT 9297
CXT 8297

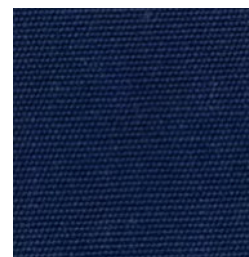

Compass Blue
MXT 9012



Abaco
MXT 9049

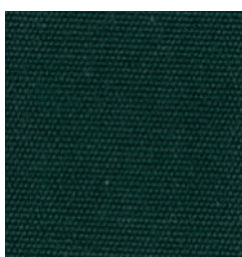

Evergreen
MXT 9047

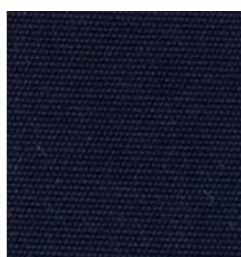

Admiral Navy
MXT 9044

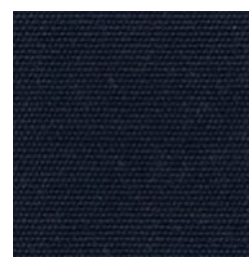

Midnight Blue
MXT 9114

SUN & FLOWERS

Sunny, warm colors and cool shades that will brighten up any patio, terrace, or outdoor setting.

No flat binding

No braid binding

Swatches shown in MXT



Canary
MXT 9303

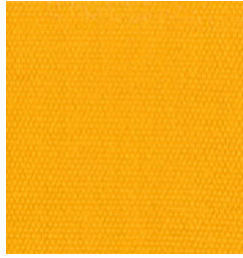

Sunburst
MXT 9016
CXT 8016



Marigold
MXT 9310



Nectarine
MXT 9304

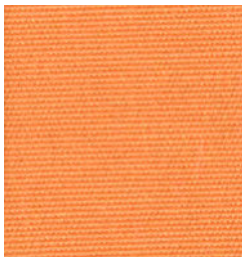

Grapefruit
MXT 9307

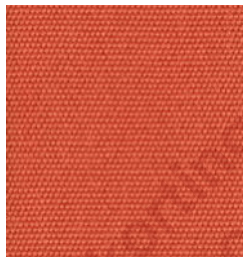

Begonia
MXT 9301



Apricot
MXT 9053
CXT 8053



Madrona
MXT 9309
CXT 8309



Peony
MXT 9311



Dragonfruit
MXT 9302
CXT 8302



Cherry
MXT 9013
CXT 8013



Scarlet
MXT 9014
CXT 8014

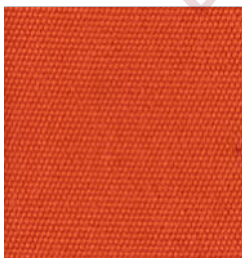

Flame
MXT 9306



Chili
MXT 9052
CXT 8052



Cabernet
MXT 9042
CXT 8042



Eggplant
MXT 9305



Violet
MXT 9312



Lapis
MXT 9308

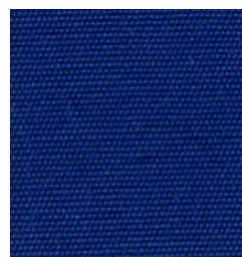

Indigo
MXT 9048

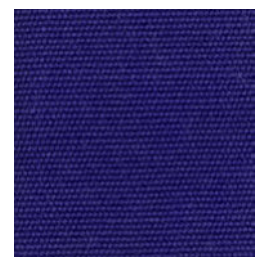

Amethyst
MXT 9300

CLASSIC STRIPES

From the French Riviera to Miami Beach, these classic stripes check all the boxes for the flawless beach palette.



Poppy Red
MXT 9319



Sun Yellow
MXT 9320



Bright Orange
MXT 9314



Cloud Grey
MXT 9315



Alpine Green
MXT 9313



Royal Blue
MXT 9074



Marina Blue
MXT 9318



Dark Navy
MXT 9317



Coal Black
MXT 9316

HORIZONS & TERRAINS

A well balanced neutral palette grounded in the colors of the earth.

Swatches shown in MXT unless otherwise noted.



Whitecap
MXT 9700
LXT 7700



Whisper Gray
MXT 9707
LXT 7707 (shown)



Moonstone
MXT 9701



Barley
MXT 9702



Sienna
MXT 9706
LXT 7706

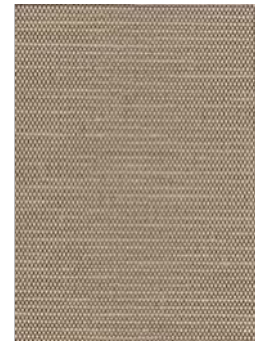

Almond
MXT 9703



Georgetown
MXT 9708



Squall
MXT 9709
LXT 7709



Meteorite
MXT 9710



Basalt
MXT 9714
LXT 7714



Daffodil
MXT 9705



Abyss
MXT 9713



Deep Emerald
MXT 9711



Earth
MXT 9712

WIND & WAVES

PREMIER PXT 10000 SERIES

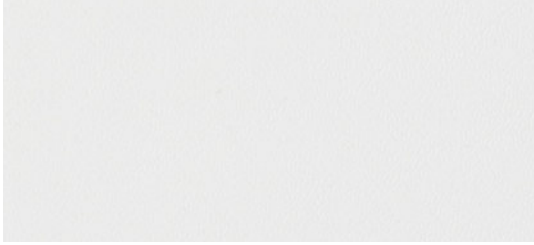

White Sail
PXT 10001

MARINE MXT 9800 SERIES



Arctic Silver
MXT 9800



Nightfall
PXT 10002

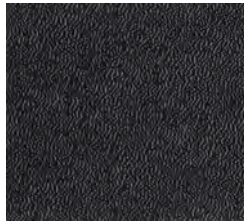

Obsidian
PXT 10003



Comet
MXT 9801



Black Pearl
MXT 9802

PREMIER PXT 10000-92 & PXT 10000-86 SERIES

Swatches shown in PXT 10000-86 series unless otherwise noted.

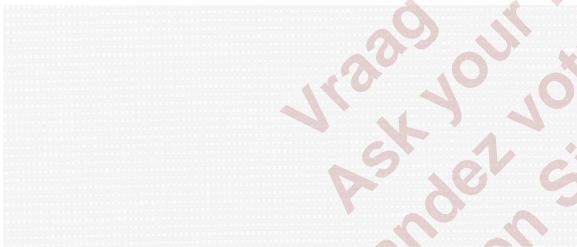

Spinnaker
PXT 10004-86
PXT 10004-92



Gateway/Spinnaker
PXT 10014-86
PXT 10014-92 (shown)

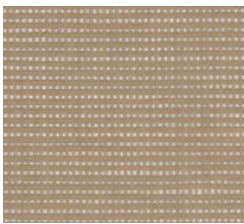

Haze
PXT 10005-86
PXT 10005-92

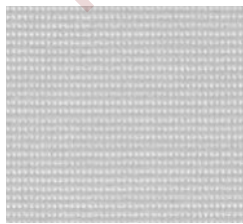

Gateway
PXT 10006-86
PXT 10006-92

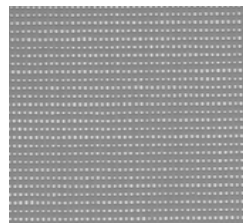

Grayhound
PXT 10007-86
PXT 10007-92

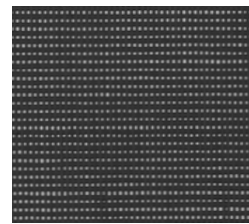

Hammerhead
PXT 10008-86
PXT 10008-92

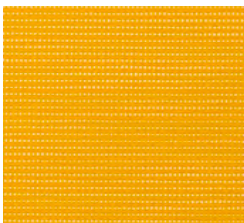

Lemon
PXT 10010-86
PXT 10010-92

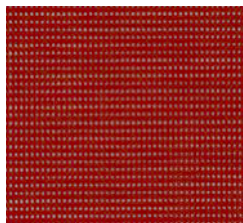

Crimson
PXT 10011-86
PXT 10011-92

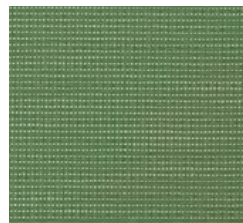

Pear
PXT 10012-86
PXT 10012-92



Raven
PXT 10013-86
PXT 10013-92

Tuuci textiles mirror the superior quality and performance expected from our parasols and shade structures. Every stitch is meticulously crafted by our skilled marine fabrication team using specialized reinforcement techniques to ensure a long-lasting shade experience.



WATER RESISTANT

Our Premier PXT and Marine MXT fabrics offer engineered moisture resistance that endures for years.



MOLD & MILDEW RESISTANT

These fabrics inherently resist the growth of mold and mildew. To keep your canopies looking clean, brush off dirt and debris regularly.

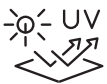

LASTING COLOR

Feel confident in choosing bold colors that resist fading with built in UV resistant technology.



DURABILITY

Our fabrics are built to perform in demanding outdoor conditions.



LEADING WARRANTY

Our 10 year limited warranty offers confidence in construction, quality and performance for our premier and marine grade fabrics.



RESPONSIBLE DESIGN

Engineered for an extended useful life and composed of recyclable materials.



HAND TAILORED CANOPY

Each canopy is carefully cut and sewn by our team of expert tailors to create our signature crisp fitting canopies designed to perform.



SUPERIOR MATERIALS

High performance marine engineering goes into every seam, every pocket, and every grommet we use.

CARE & MAINTENANCE

Tuuci's High Performance Textile parasol canopies employ the most durable and state of the art outdoor fabrics and thread, including proven high-performance, UV stable materials. Proper care and maintenance are important to extend the serviceable life of all Tuuci products.

Learn more at tuuci.com/resources/care-maintenance

WARRANTY

Tuuci constructs its shade structures with the finest materials available. We test our products in extreme weather environments to ensure stability, durability, and years of worry-free service. In addition, Tuuci personnel carefully follow specific quality control procedures and inspect each product to ensure our shade platforms exceed your expectations and provide a shade experience like no other in the world.

Learn more at tuuci.com/resources/warranty

ENHANCEMENT OPTIONS*

MARKET CUT PROFILE



FISHTAIL PROFILE
Only available on octagon and hexagon canopies



DOUBLE SIDED CANOPY
with braid binding (same cost as shade recover pp. 128-129)
Not available on Ocean Master MAX F-1



CONTRASTING BINDING
Binding on canopy edge and vent



ACCENT BORDER
15cm accent border on top and underside of the canopy



CONTRASTING POCKETS
Pocket color on top and underside of canopy
€130 list upcharge for M1
€285 list upcharge for MAX



CONTRASTING WIND VENT
The standard is matching. Please specify when a contrasting vent is preferred.
€175 list upcharge



ALTERNATING PANELS
€185 list upcharge for M1
€285 list upcharge for MAX



THREE PIECE ALTERNATING PANELS
Straight valance
Only available on Pagoda



THREE PIECE ALTERNATING PANELS
Teardrop valance
Only available on Pagoda



DOUBLE WIND VENT
Only available on Ocean Master M1 Classic hexagon and octagon



STRAIGHT VALANCE
with braid binding



SCALLOPED VALANCE
with braid binding



CLASSIC ROMAN VALANCE
with braid binding



MODERN ROMAN VALANCE
with braid binding



SEA SCALLOP VALANCE
only available on Cupola



ENHANCEMENT OPTIONS*

CORD FRINGE

Standard 15cm length

€545 list upcharge for M1

€910 list upcharge for MAX

€1545 list upcharge for MEGA MAX

€125 net surcharge for COM goods



BRUSH FRINGE

Standard 5cm length

€310 list upcharge for M1

€565 list upcharge for MAX

€990 list upcharge for MEGA MAX

€125 net surcharge for COM goods



GUTTER

€440 list upcharge for M1

€1010 list upcharge for MAX

€1655 list upcharge for MEGA MAX



PROTECTIVE COVER BAG

Center Post

Cantilever/
Dual Cantilever



LIFT OPTIONS

PREMIUM AND ESSENTIAL PARASOLS

CENTER POST
MANUAL LIFT WITH PIN



CENTER POST
DOUBLE PULLEY WITH PIN



CENTER POST
AUTO-LOC MARINE PULLEY LIFT
Standard for M1 Center Post



CENTER POST
EASYDRIVE CRANK LIFT



CANTILEVER
MANUAL PISTON ASSISTED LIFT
Standard for M1 Cantilever



CANTILEVER
EASYDRIVE CRANK LIFT
Standard for MAX Cantilever



*Not all enhancements and lift options are available on all collections.

FINISH OPTIONS

FLAGSHIP FINISHES



POWDER COAT SHOWN WITH NORTHSTAR MAST UPGRADE



PLANTATION ALUMA-TEAK SHOWN WITH NORTHSTAR MAST UPGRADE



VINEYARD DURA-TEAK



CUSTOM CANOPY LOGO PRINTING

	LOGO SIZE	PROJECT SET UP FEE	LOGO PER CANOPY PANEL	PROJECT RE-DO SET UP FEE (LOGO MUST BE THE SAME AS PREVIOUS ORDER)
ONE COLOR	0-90CM / 0-36"	535	35	270
	91-150CM / 37-60"	615	70	345
	151-225CM / 61-90"	735	105	460
TWO COLORS	0-90CM / 0-36"	1065	70	535
	91-150CM / 37-60"	1230	140	695
	151-225CM / 61-90"	1470	210	885
THREE OR MORE COLORS	0-90CM / 0-36"	1445	85	745
	91-150CM / 37-60"	1675	110	985
	151-225CM / 61-90"	1975	190	1280

LOGO SIZES OVER 230CM / 91" AND LOGOS/GRAPHICS REQUIRING COMPLEX CUSTOM STYLING MAY REQUIRE ADDITIONAL CHARGES; PLEASE CONTACT YOUR TUUCI SALES TEAM FOR ASSISTANCE.

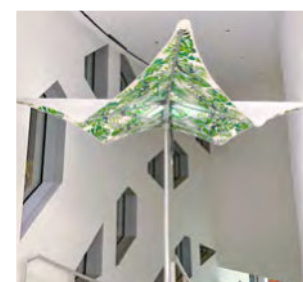

ARTWORK REQUIREMENTS



All information below is required when requesting a quote and/or proof.

- Original logo, also known as a vector file – this is an “.ai” or “.eps” file
- Parasol size
- Canopy shape, for example:

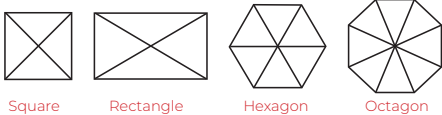

Square Rectangle Hexagon Octagon

- Profile of the parasol – market, valance or fishtail
- Fabric color and grade
- PMS colors for logo (no metallics)
- Placement of artwork on panel(s) and/or valance(s). For example:

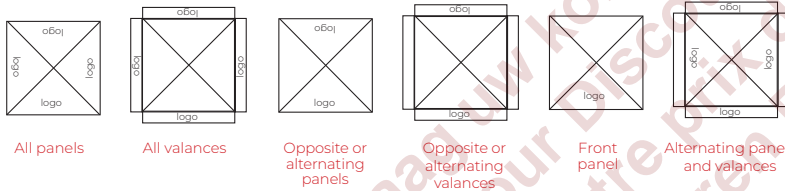

All panels All valances Opposite or alternating panels Opposite or alternating valances Front panel Alternating panels and valances

- 2-day turnaround for new proof
- €260 charge for JPEG'S or PDF that need to be converted to vector artwork (an additional 3-day turnaround for new vector artwork)
- Proofs will be sent via email for approval
- Production will not begin until signed approval is returned to Tuuci
- Proofs will remain on file for future repeat orders
- Not all PMS colors are available in outdoor ink. We will select the closest match when creating the proof, in the event the specified pms is not available.

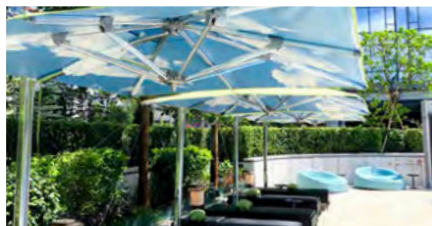
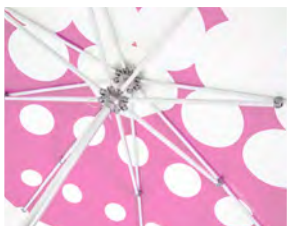

CANOPY CLEANING SERVICE



Tuuci provides professional cleaning of your canopy as an additional service.

Pricing: **€25,- p/m² NET** (excl. shipping)

Please contact us in case you have further questions.



IDENTIFY YOUR PARASOL

TUUCI® PARASOLS HAVE A UNIQUE PRODUCT ID # TO IDENTIFY THE MODEL & STYLE

Center Post



ID/job number is located below the top hub on center post mast.

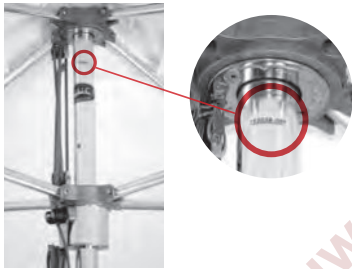

Cantilever



ID/job number is located on the back top of cantilever mast.



IF YOUR PRODUCT ID/JOB NUMBER IS MISSING, YOU WILL NEED TO IDENTIFY YOUR PRODUCT BY MEASURING A RIB

Sample rib set & frame



Measure a to b and c to d

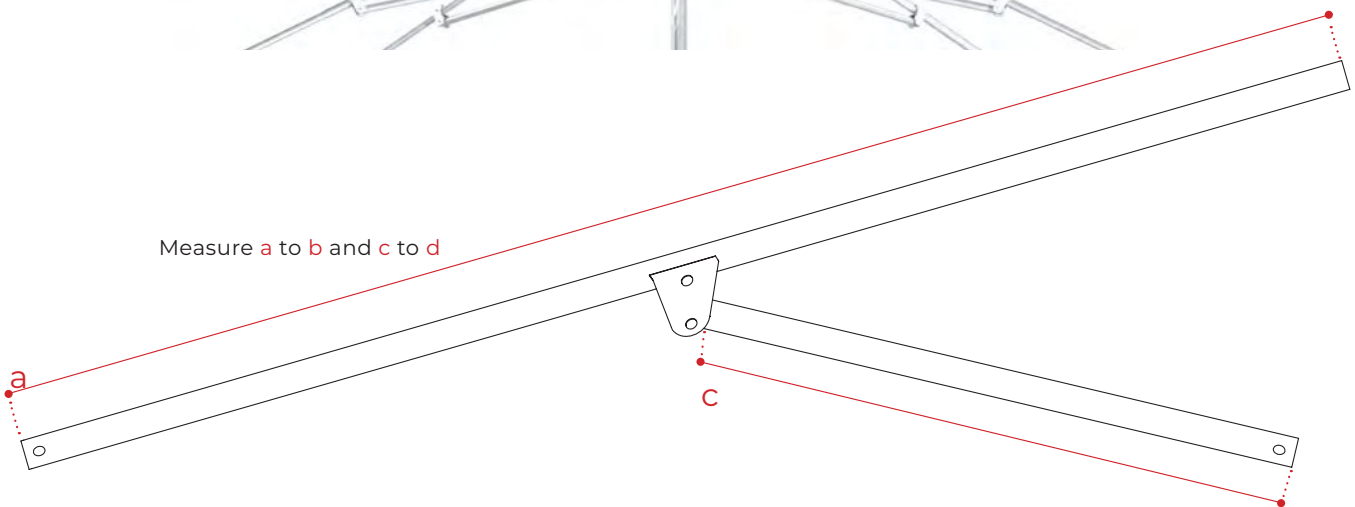

CARE & MAINTENANCE T&C

Tuuci frames are constructed from durable, marine grade, weather-resistant materials including fiberglass, armor-wall aluminum, Vineyard Dura-TEAK composites, Plantation Aluma-TEAK aluminum and sustainable hardwood. All fasteners (nuts, bolts, pulleys, cam cleats, etc.) are marine grade stainless steel and will withstand most corrosive environments. Proper care and maintenance are important to extend the serviceable life of all Tuuci products.

ROUTINE CARE FOR YOUR TUUCI PARASOL

- Before you open the shade product, ensure that it is properly secured to an adequate anchor, using its intended locking system (star knob, hitch pin or cam lock).
- Rinse once a week with fresh water.
- Inspect your product weekly.
- Tighten loose screws and replace broken components immediately to avoid further damage.

When opening a Tuuci parasol, separate each rib 15cm / 6 inches from the center post, before raising the hub. Do not force the hub if it does not rise easily.

When closing the parasol, pull the fabric out from between the struts to avoid pinching or damaging the High Performance Textile canopy.

TUUCI IN HIGH WIND

Although many Tuuci frames have been tested for structural integrity in winds exceeding 80 kmh / 50 mph, you must use caution and common sense in extreme wind and weather conditions. Close all collapsible shade equipment in conditions which exceed 40 kmh / 25 mph. Stability of Tuuci shade products in heavy wind and severe weather conditions is directly related to the size, weight, and security of the shade anchor. Use reasonable and cautious judgment when determining when the parasol should be closed.

ROUTINE CARE FOR SHADE ANCHORS

ALWAYS BE SURE THAT THE PARASOL CENTER POLE IS FIRMLY ATTACHED TO ANCHOR BEFORE OPENING PARASOL.

Clean above ground parasol anchors gently and regularly with soap and water using a non-abrasive cloth or pad to maintain appearance. Check all bolts in anchor plate regularly to ensure that they remain fully tightened. Inspect weekly if parasol anchors are moved on a regular basis.

Do not roll Aluma-CRETE (aluminum shell, concrete filled) anchors on their side as damage to shell or finish will occur. Touch up anchors with exterior paint as needed. Order touch up paint by emailing info@tuuci.eu. Wheeled parasol anchors are intended for use on even surfaces. Move anchors slowly and with caution on uneven surfaces. Do not use on stairways or over distances which exceed 15m / 50 feet, as damage to welded wheel tray may occur.

HIGH PERFORMANCE TEXTILE CANOPIES, CURTAINS, AND TENSIONED FABRIC WALLS

Tuuci's High Performance Textile canopies employ the most durable and state of the art marine fabrics and thread, including proven high performance, UV stable materials.

ESSENTIAL CANOPY CLEANING

Clean Tuuci High Performance Textiles regularly before dirt accumulates and becomes embedded in the fabric. The fabric canopy can be cleaned without being removed from the frame.

1. Simply brush off any loose dirt or particles; hose down and clean with a mild soap in lukewarm water (no more than 38° C / 100° F.)
2. Rinse thoroughly to remove soap.
3. Allow fabric to air dry.

STUBBORN CANOPY STAINS

Clean with a mild soap and add one cup of bleach to a gallon of water, scrub vigorously with a soft bristle brush, sponge or clean towel. Allow fabric to air dry. This method of cleaning may remove part of the water repellency. If water repellency is a factor, the fabric should receive an application of an air-curing water repellent treatment (such as SM fabric guard).

DO NOT WASH OR CLEAN WITH EXCESSIVE HEAT OR THE FABRIC WILL SHRINK.

AIR DRY ONLY. DO NOT STEAM PRESS OR DRY USING OTHER METHODS.

If you store your parasol during the winter, clean the High Performance Textile canopy, air dry it, and store it in a dry, well-ventilated area. Always use a Tuuci protective cover when you are not using the parasol to extend its serviceable life.

PARASOL REPAIR

Proper care and maintenance should prevent broken parasols, but in the case your parasol is in need of repair, all Tuuci products are built with 100% replaceable parts. Order Tuuci products by emailing info@tuuci.eu.

WARRANTY INFORMATION

Tuuci® constructs its shade structures with the finest marine grade materials available. We test our products in extreme weather environments to ensure stability, durability and years of worry-free service. In addition, Tuuci personnel carefully follow specific quality control procedures and inspect each product to ensure freedom from manufacturing defects. Our goal is to produce shade platforms that will exceed your expectations and provide a shade experience like no other in the world. The limited warranty protection detailed below covers manufacturing defects only.

Premium Parasols - Ocean Master™ M1, Ocean Master™ MAX, Ocean Master™ MEGA MAX

15 years

Entire frame structure, including mast, hubs, struts, brackets and hardware

5 years

Frame finishes, including powder coat and Tuuci's exclusive Plantation Aluma-TEAK
Ocean Master MAX Nautical Teak structure
Manual lift systems and related components, including gear boxes and worm drives

1 year

Electrical components, including LED lighting, heaters and automation components

Aluminum Framed Cabanas – Solanox™ Cabana

15 years

Entire frame structure, including trellis walls, trellis roof, beams, columns and bench supports

5 years

Frame finishes, including powder coat and Tuuci's exclusive Plantation Aluma-TEAK
Louvered Roof mechanical components

1 year

Electrical components, including LED lighting, heaters and automation components

G-Plate, In-ground, Aluma-CRETE, Aluma-CRETE Cube Shade Anchors

15 years

Stainless steel stems, flush mounts, security mounts, bottom plates, frames
Galvanized steel plates

5 years

Stainless steel hardware (hitch pins, bolts, star knob)
Beauty covers, concrete pavers, filled concrete
Finishes, including powder coat and Tuuci's exclusive Plantation Aluma-TEAK

Essential Parasols – Bay Master™ M1 and Bay Master™ MAX

5 years

Entire frame structure, including mast, hubs, canopy ribs and hardware
Frame finishes, including powder coat finishes and Vineyard Dura-TEAK

1 year

Electrical components, including LED lighting

Atlantis™, Grand Pacific™, and St. Tropez™ Cabanas; Solanox™ Double Chaise, Mercury™ and Crescent™ Lounges; Wave Stand™; Stingray™ Shade Sculpture; Urban Garden Planters

5 years

Entire frame structure, including trellis walls, trellis roof, beams and columns.
Frame finishes, including powder coat and Tuuci's exclusive Plantation Aluma-TEAK

1 year

Air Lounge